

CARDIO

UK

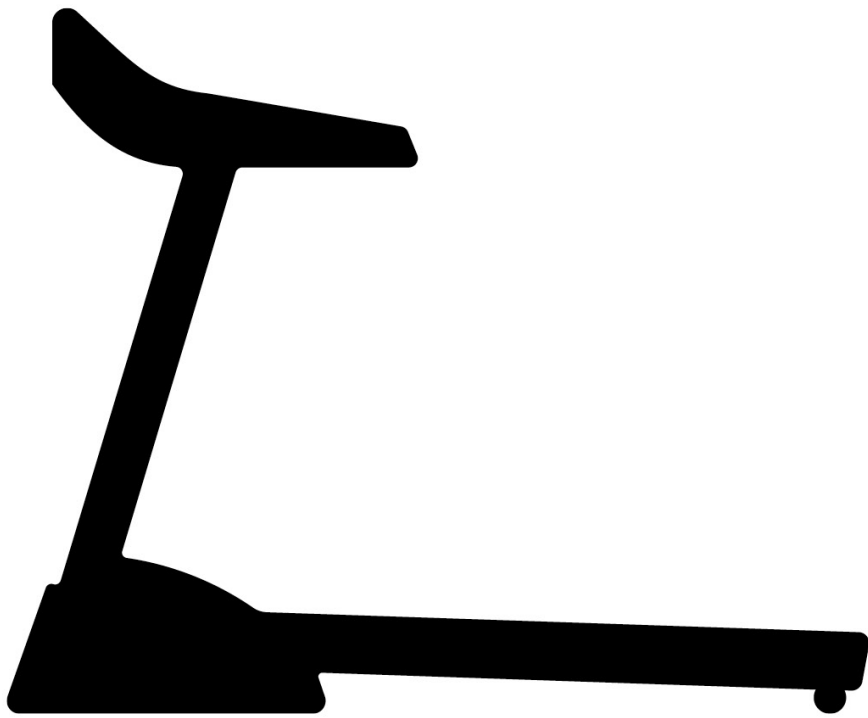

TREADMILL T65

TITAN LIFE®

TABLE OF CONTENTS

READ THIS OWNER'S MANUAL BEFORE OPERATING YOUR TREADMILL	4
DEAR CUSTOMER	7
CUSTOMER SERVICE	8
DISPOSAL	9
WARRANTY	10
SAFETY INSTRUCTIONS	12
IMPORTANT SAFETY INFORMATION	15
MAINTENANCE	17
CLEANING	21
HEART RATE WORKOUTS	22
WARMING UP	24
GENERAL WORKOUT PROGRAMME	27
HELP IN ATTAINING YOUR WORKOUT GOALS	28
USER INSTRUCTIONS	29

READ THIS OWNER'S MANUAL BEFORE OPERATING YOUR TREADMILL

IMPORTANT – SEE PAGE 19 FOR INFORMATION ON
TREADMILL LUBRICATION.

THIS INFORMATION HAS BEEN PROVIDED TO EXTEND YOUR
TREADMILL'S LIFETIME.



When starting up your treadmill, stand with your two feet on the two side panels.



When the belt reaches a speed of 2 km/h, you can step on the belt and start walking.

DEAR CUSTOMER

We are extremely pleased that you have chosen a product from TITAN LIFE. This is a high-quality product designed for home usage. It has been tested to the European EN 957 standard. Please carefully read this entire owner's manual Before you assemble and start to use your treadmill. We recommend that you retain the manual for future reference.

CUSTOMER SERVICE

So that we can offer you the best service in the event of a problem, a malfunction or defect for instance, please save the product's serial number in a safe place. It can be found on the tag affixed to the bottom of the treadmill's frame. You should fill in the following items on the tag. We will need this information if you need to contact us at any time regarding your product. We also recommend that you keep the following information together with your receipt of purchase. You will be required to show your receipt in the event of a claim, if requested.

Brand:

e.g. TITAN LIFE

Product type:

e.g. Treadmill

Model name:

e.g. ATHLETE T'11

Serial number:

e.g. re-12011/5212/45101-01

Date of purchase:

e.g. 20/10/2020

Where purchased:

e.g. Expert Sport Norge

ORDER REPLACEMENT PARTS

If you ever need to buy replacement parts, you will find the product numbers for these in either the list of parts or the component diagram in this owner's manual. When ordering, contact our Customer Service department as follows:

DK: www.livingsport.dk

SE: www.livingsport.se

FI: www.livingsport.fi

NO: www.livingsport.eu

DE: www.livingsport.info

UK: www.livingsport.info

Have the serial number, model number, your receipt, and owner's manual at hand when you contact us.

DISPOSAL

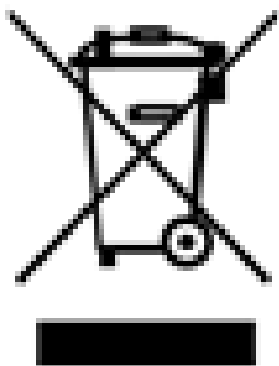

This symbol means that the product may not be disposed of as household waste. It is your responsibility to take the product to an appropriate collection point for recycling electrical and electronic equipment. This scheme helps to conserve natural resources and prevent any adverse impacts on human health or the environment.

WARRANTY

TITAN LIFE's quality products are designed and tested for home use. This means that the warranty will become null and void if you use the product for commercial, public, or other non-private use.

This product has been manufactured according to the European EN 957 standard.

As an importer of your TITAN LIFE product, LivingSport A/S offers a two-year warranty under the Danish Sale of Goods Act. The warranty covers manufacturing and material defects found during normal use of the product. The warranty does not cover any defects, damage, or wear caused directly or indirectly as a result of improper operation, poor maintenance, violent use, or tampering. LivingSport A/S cannot be held liable for any damage to other household effects incurred in connection with the use of the product. Claims in respect of defects or shortcomings, which should be detected through normal examination of the product, should be addressed to LivingSport A/S within a reasonable time.

The product can be returned for repair in the event of defects or shortcomings. This **MUST** be agreed with LivingSport A/S prior to the return. Once we assess the extent of the defect or shortcoming, we will attempt to remedy the problem during repair. If this cannot be done within a reasonable time and without major inconvenience to the consumer, we will exchange the product or a credit can be considered. The warranty period begins on the day of delivery. Therefore, please retain your purchase receipt and delivery slip in a safe place.

If you need to make a product claim, please visit:

DK: www.livingsport.dk

SE: www.livingsport.se

FI: www.livingsport.fi

NO: www.livingsport.eu

DE: www.livingsport.info

UK: www.livingsport.info

SAFETY INSTRUCTIONS

You should consult your doctor before beginning this or any other workout programme. This is particularly important for people who have not exercised regularly previously, or those with current or previous health problems.

Please read this manual carefully before beginning your workout. The manufacturer and retailer assume no liability for personal injury or damage to household effects caused by or through use of this product. Carefully read all precautions and instructions for the use of the product. We recommend that you keep this manual for future reference.

- It is the owner's responsibility to ensure that all users of the product are adequately informed of all precautions. Use this product only as described in this manual.
- Use this product indoors only, on a smooth surface, ensuring sufficient free space around the product. Do not place the product outdoors, in a garage, under a carport, in a shed, or near water.
- Keep the product away from moisture and dust.
- ALWAYS keep children under 12 and pets away from the product.
- If necessary, place a mat under the stabilisers to protect wooden floors and carpets.
- regularly check to ensure that all screws and bolts are properly tighten.
- Immediately replace any worn or broken parts.
- Damaged parts or components may pose a risk to your safety

and impair the product's lifetime. Therefore, replace damaged or worn parts immediately and do not use the product before you do so.

- Repairs may only be carried out in consultation with LivingSport A/S.
- Ensure that NO LIQUID enters the machine or electronic parts, as this may cause damage to the product.
- The product should be stored at normal room temperature, in other words not below 15°C.
- Wear appropriate clothing when exercising. Avoid wearing loose clothing or accessories that could become entangled in the product's moving parts.
- Always wear athletic shoes or trainers when exercising.
- Keep your back straight while exercising. Do not bend your back.
- If you feel pain or dizziness while exercising, you should stop immediately!
- If your product is fitted with a hand pulse monitor, be aware that the monitor is not a medical device and that you can expect a certain margin of error when measuring your heart rate as compared with the measurements of your pulse rate direct from your heartbeat. Several factors, including the way the user moves, can influence the precision of a hand pulse monitor.
- The hand pulse monitor should be regarded as a training tool to determine your general heart rate.
- The product is classified as an "H" product (for home use) and is therefore only intended for exercise use at home. It should therefore not be used within commercial or institutional

environments.

- The product is NOT designed for medical or rehabilitative purposes.
- The product is manufactured according to the European EN 957 standard and is not intended for therapeutic or curative exercise.
- For maximum user weight see USER INSTRUCTIONS.
- If your product has heart rate then please note this: WARNING! Heart rate monitoring systems may be inaccurate. Over exercising may result in serious injury or death. If you feel faint stop exercising immediately.
- Emergency dismount; clear safety area of at least 2 000 mm in length and at least as wide as the treadmill shall be provided behind the equipment when in use. If your product has heart rate then please note this: WARNING! Heart rate monitoring systems may be inaccurate. Over exercising may result in serious injury or death. If you feel faint stop exercising immediately.

Noise emission under load is higher than without load.

IMPORTANT SAFETY INFORMATION

Position your treadmill close to an electrical outlet. Always plug the power cord into a grounded outlet. Ensure that no other power-consuming items are plugged into the same outlet. We recommend that you do not use an extension cord. The product is rated for 220-240-volt outlets. Only allow adults to connect the treadmill to the mains.

If in doubt about how to connect your treadmill, or whether it is safe to do so, you should contact a qualified electrician. You must not attempt to modify the cord or adapter.

The cord must not come into contact with the treadmill! You should therefore not route it under the treadmill or under the rear or front rollers. Do not use the treadmill if the cord is defective!

Turn off the power and unplug the cord during maintenance. Ensure there is no damage to the treadmill and that everything is tensioned before use. The treadmill must not be used outdoors or placed in direct sunlight. When in the "On" position, the treadmill should always be supervised by an adult.

ASSEMBLY

Before starting up your machine, it is important that you carefully read all the steps for assembly. We recommend that you consult the three-dimensional exploded view diagram while doing so.

Dispose of all packaging and loose material before assembling the product. Ensure that all parts have been included and are free of

damage before starting with assembly. Use the enclosed list of materials to double-check that this is the case.

Use care when assembling the product. Ensure that you can concentrate and that no one disturbs you during assembly. Children should never be present during the assembly of the product!

MAINTENANCE

The product must be tensioned before each use and it should be checked for any defects, vibrations, strange noises, and missing parts. If you are unsure whether the product has a defect, cease using it and contact LivingSport A/S' Service Department. In particular, take note of the screws and bolts securing the moving parts, whether visible or hidden. If the fault occurs due to improper operation, lack of tensioning, or maintenance, the warranty will become void. Furthermore, LivingSport A/S takes no responsibility for faults which may occur on second and third parties.

It is important that the treadmill is properly maintained, in order to prevent faults and to ensure its smooth functioning. If you fail to maintain your treadmill, you may impair its useful life and risk the warranty becoming void.

**ALL PARTS SHOULD BE CHECKED AND TENSIONED REGULARLY!
DEFECTIVE PARTS MUST BE REPLACED IMMEDIATELY!**

ADJUSTING THE TREADMILL/BELT

You may need to adjust the treadmill/belt after the first few weeks of use because the rubber parts may expand a little. If you notice the treadmill slipping or "standing still" when you take a forward step, the treadmill/belt needs to be tightened.

TENSIONING THE TREAD-BELT

1. Use an 8mm wrench for the left adjustment bolt. Turn it clockwise by a $\frac{1}{4}$ turn.
2. Repeat STEP 1 with the right adjustment bolt. Ensure that you turn each bolt the same number of turns. If you fail to do so, the belt will start running askew and you risk destroying the belt.
3. Repeat STEP 1 and STEP 2 until the belt stops slipping/moves from its "standing still" position.
4. Be careful not to overtighten the belt, as this may damage the front roller's ball bearings. If this happens, you will hear a metallic noise coming from the roller.

To reduce load on the rollers (to loosen the belt), turn both the right and left bolts clockwise the same number of turns.

CENTRING THE TREADMILL / BELT

When you run, it is normal that you push off harder with one foot than with another. However, with time, this may lead to the belt being pulled askew. The treadmill will usually re-centre itself by simply being allowed to run without any load on it, meaning no one standing on it while it is running. If this does not remedy the problem, you should adjust your treadmill manually.

- Start the treadmill/belt, allowing it to run at 6 km/h and ensuring there is no load on it. Observe whether the belt is pulls to the right or the left.

- If it pulls to the left, use the wrench to turn the left adjustment bolt. Turn the left bolt clockwise by a ¼ turn.
- If it pulls to the right, use the wrench to turn the right adjustment bolt. Turn the right bolt clockwise by a ¼ turn.
- Repeat the above until you centre the belt.

Once you centre the belt, set the speed at around 12 km/h. Check whether the treadmill is running normally and without any strange sounds.

If the above procedure proves inadequate to centre the belt, you may need, as mentioned above, to tighten the tread-belt.

Refer to the illustration below.

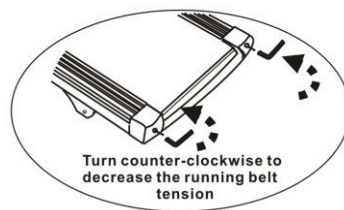
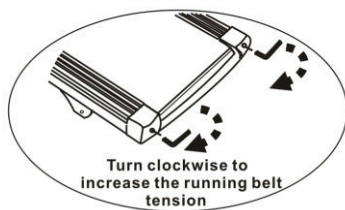

LUBRICATION

Before using your treadmill for the first time, you should check whether it has arrived adequately lubricated by the manufacturer:

Lift the belt and feel the underside. If you find any traces of silicone, you do not need to re-lubricate the belt.

If the surface is dry, follow the “Lubricating your Treadmill” instructions below.

Your treadmill should be lubricated regularly. Lubricate it at monthly intervals or after approx. 40 workout hours. Only use an authorised silicone spray or the bottle supplied with the treadmill. If you wish to buy items in addition to those supplied, please contact info@livingsport.dk for referral to your nearest dealer.

LUBRICATING THE TREADMILL

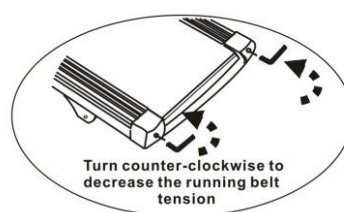
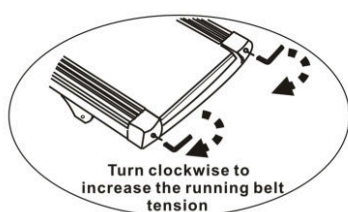

STEP 1:

Use the Allen wrench supplied to loosen the screws towards the end of the belt, as shown above. Turn clockwise about 10 times.

STEP 2:

Lift the belt up and, using the bottle supplied, lubricate the wooden board in an S-shaped pattern. You will need approx. half the bottle.

STEP 3:

Next, retighten the belt.

STEP 4:

Run the treadmill at a speed of 5-6 km/h, without standing or walking on it, for about 5 minutes, so the oil can be worked into the belt. Lastly, turn the speed to the highest setting and check that the belt is running straight.

CLEANING

Regular cleaning ensures your treadmill lasts longer!

WARNING: The treadmill may not be connected to a power source during cleaning! The power plug should be disconnected from the electrical socket when the treadmill is not in use, and must be during maintenance and during cleaning.

Note: Do not use any soap or detergents. To avoid damage to the console, keep clear of all liquids.

Wipe the console and all other surfaces using a dry cloth after each workout! Do not leave the console in direct sunlight.

Remove the motor cover approx. every 6 months and vacuum the motor compartment. REMEMBER disconnect from the power source

It is important that where you place your treadmill is a dust-free environment. Also remember to clean under and around the treadmill.

To make cleaning easier, you should use a mat under the treadmill.

Clean the mat at least once a week.

STORAGE

The treadmill should be stored in a clean and dry room, and at a minimum temperature of 15 degrees. Ensure that the power is turned off and that the cord is not plugged into the outlet.

HEART RATE WORKOUTS

On normal days, our body uses oxygen to convert nutrients from the food we eat into energy for use by our muscles and in other bodily functions. The amount of energy we use is measured in calories. The following rule of thumb applies: if we burn more calories than we consume, the body will source fuel from the calories that the body stores as fat. This will lead to fat being turned into muscle, which will improve our posture and make the body healthier overall.

When we exercise, our heart rate increases to supply a sufficient amount of oxygen to the muscles being used. Regular cardiovascular activities, such as cycling, running, rowing, or working out on a crosstrainer, will result in a stronger heart and stronger lungs that can more effectively distribute oxygen to the muscles. In turn, muscles can more effectively convert calories into energy.

However, to ensure you improve your health in a safe and reliable way, it is necessary that you very accurately estimate the pulse rate you are going to work out at. You do this by setting your maximum heart rate (MHR). This is the maximum number of times your heart can beat per minute.

How to set your maximum heart rate:

Men: Estimated MHR = 220 minus your age

Women: Estimated MHR = 226 minus your age

Use the following table to determine the level at which you should work out based on your heart rate.

HEART RATE DIAGRAM

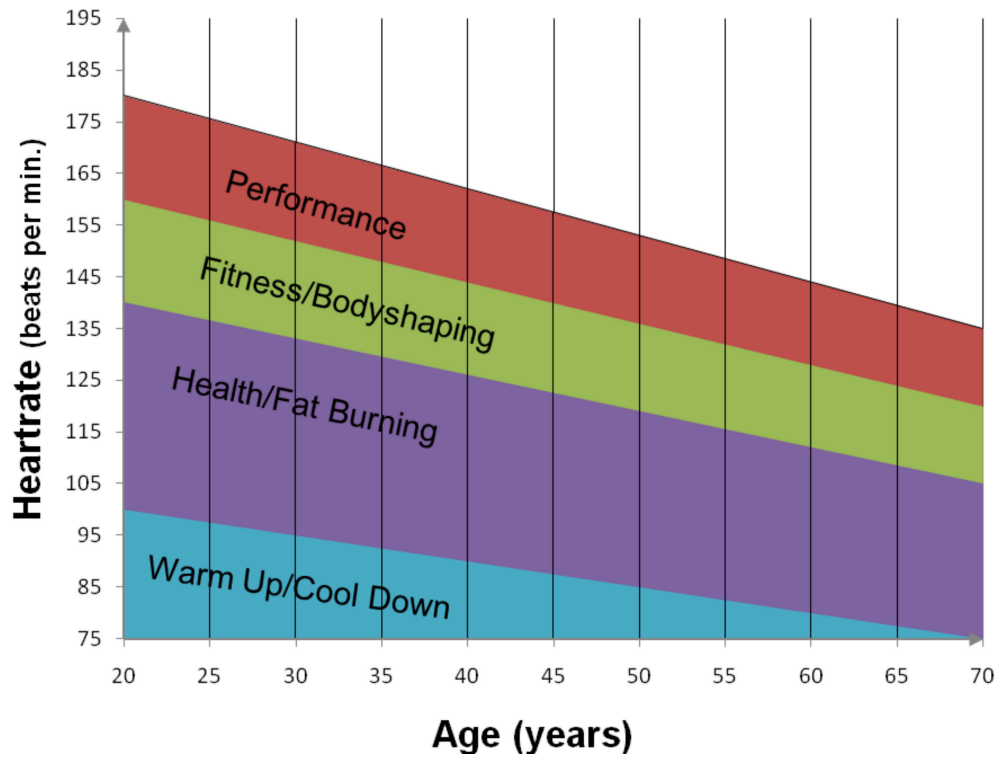

WARMING UP

FLEXIBILITY

Flexibility is described as the range of motion around a joint, where two or more bones come together. By maintaining your joints and improving your flexibility, you will be less susceptible to injury or arthritic infirmity. You should try to gently improve your flexibility using a couple of stretching exercises. Stretching exercises should always be a part of your warm-up and cool-down routines. You can then continue to increase your flexibility during your normal workout.

WARMING UP AND COOLING DOWN

A successful exercise programme consists of a good warm-up, aerobic exercise, and cool-down. Do this programme two or three times a week with a day between workouts. After several months, you can increase your workouts to four or five times a week.

Warming up is a very important component of your exercise programme and it should be done before every workout. It prepares your body for a very strenuous workout by warming up and stretching your muscles. It also improves your circulation and increases your pulse, and delivers more oxygen to your muscles.

We recommend that you repeat the exercises shown here after your workout to reduce exercise pain.

TOUCHING YOUR TOES

Slowly bend forwards from the hips, keeping your back and arms relaxed while stretching downwards towards your toes. Stretch down as far as you can and hold that position for 15 seconds. Bend your knees slightly.

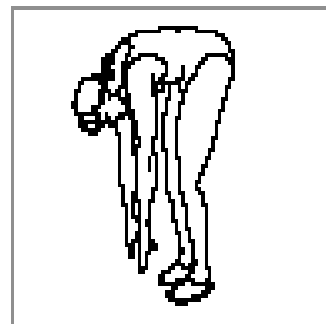

SHOULDER LIFTS

Raise your right shoulder up towards your right ear and hold for 2 seconds. Next, raise your left shoulder up towards your left ear and hold for 2 seconds, while lowering your right shoulder.

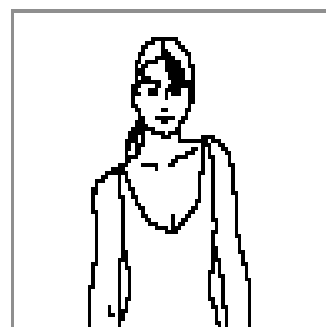

HAMSTRING STRETCHES

Sit with your right leg outstretched. Rest the sole of your left foot against the inside of your right thigh. Stretch your right arm out along your right leg as far as you can. Hold for 15 seconds. Relax and then repeat with the left leg and left arm.

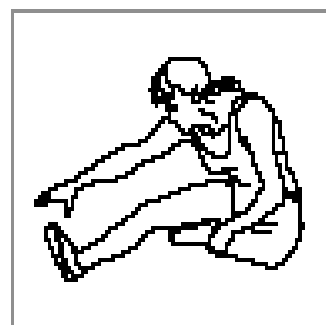

SIDE STRETCHES

Raise your arms above your head. Stretch your right arm up towards the ceiling as far as you can. Then repeat the exercise for your left arm.



CALF/ACHILLES STRETCHES

Lean against a wall with your left leg in front of the right and your arms forwards. Stretch out your right leg, keeping your left foot on the floor. Next, bend your left leg and lean forwards by moving your right hip in the direction of the wall. Keep your leg stretched and repeat the exercise for the other leg.

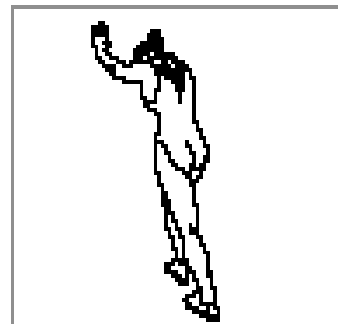

HEAD ROLLS

Slowly tilt your head to the right, stretching out the left side of your neck. Hold for 20 seconds. Next, tilt it back again to the left and continue on until the right side of your neck is stretched out. Then, slowly tilt your head forwards and stick out your neck. Never rotate your head all the way round!

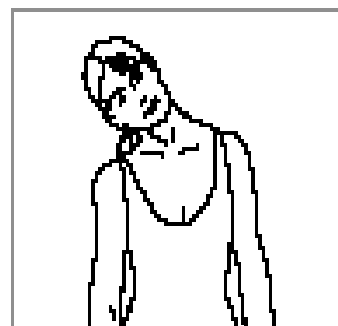

Repeat the exercise several times.

GENERAL WORKOUT PROGRAMME

DESIRED RESULT	WORKOUT LEVEL
<p>More active lifestyle</p> <ul style="list-style-type: none"> • Improve functional capacity • Reduce risk of disease • Physical well-being 	<p>Level 1</p> <p>Work with a heart rate of 40-60% of your maximum</p>
<p>A healthier heart – burn fat</p> <ul style="list-style-type: none"> • Improve cardiovascular health • Weight loss • More energy • Reduce blood pressure • Reduce cholesterol levels • Boost immune system • Reduce stress 	<p>Level 2</p> <p>Work with a heart rate of 61-70% of your maximum</p>
<p>Fitness – stamina</p> <ul style="list-style-type: none"> • Improve cardiovascular health • Improve aerobic capacity and stamina 	<p>Level 3</p> <p>Work with a heart rate of 71-85% of your maximum</p>
<p>Competition training</p> <ul style="list-style-type: none"> • Shift oxygen limit • Improve competition results 	<p>Level 4</p> <p>Work with a heart rate of 86-100% of your maximum</p>

HELP IN ATTAINING YOUR WORKOUT GOALS

As previously described, there are a range of benefits from exercising, including better sleep and an improved metabolism so that you burn fat even when you are not exercising, better posture that reduces the risk of back pain, and enhanced self-esteem from all the health benefits. We recommend that you do not use your weight loss as the only indicator of your results. Instead, look at yourself in the mirror, which is a far better indicator of success when you are turning fat into muscle.

Do not set unrealistic goals when you begin working out. That will quickly give rise to sore muscles, resulting in a lack of motivation when you fail to achieve your goals. Instead, get on the bike for 20 minutes three times a week, in order to allow your body to recover. Remember: what you are putting into effect is a change of lifestyle, so let it take the time it needs. Try not to do too much all at once to get in shape. Long-term success tends to be easier to achieve when you start slowly. Take one step at a time and make sure that you feel comfortable with your new habits. That way, you won't give up and fall back into an inactive lifestyle. It is also important to understand that several elements of everyday life can help or hinder you in achieving your goals. What you eat has a strong bearing on your well-being, and so it is important to eat healthily. On top of that, there are lots of little things in everyday life that can bring about a positive result, such as using the stairs instead of the lift. And remember, even if you do not do these things every day, every little bit helps.

USER INSTRUCTIONS

Maximum userweight 150KGS

1. Brief Description

GV-5055 motorized treadmill (diagram 1) can help complete your goal of keeping fit together with unique and elegant appearance. Easily read panel parameter. Easily operated folding system realizes space-saving. Auto speed range 1-20km/h and auto incline range 0-22.

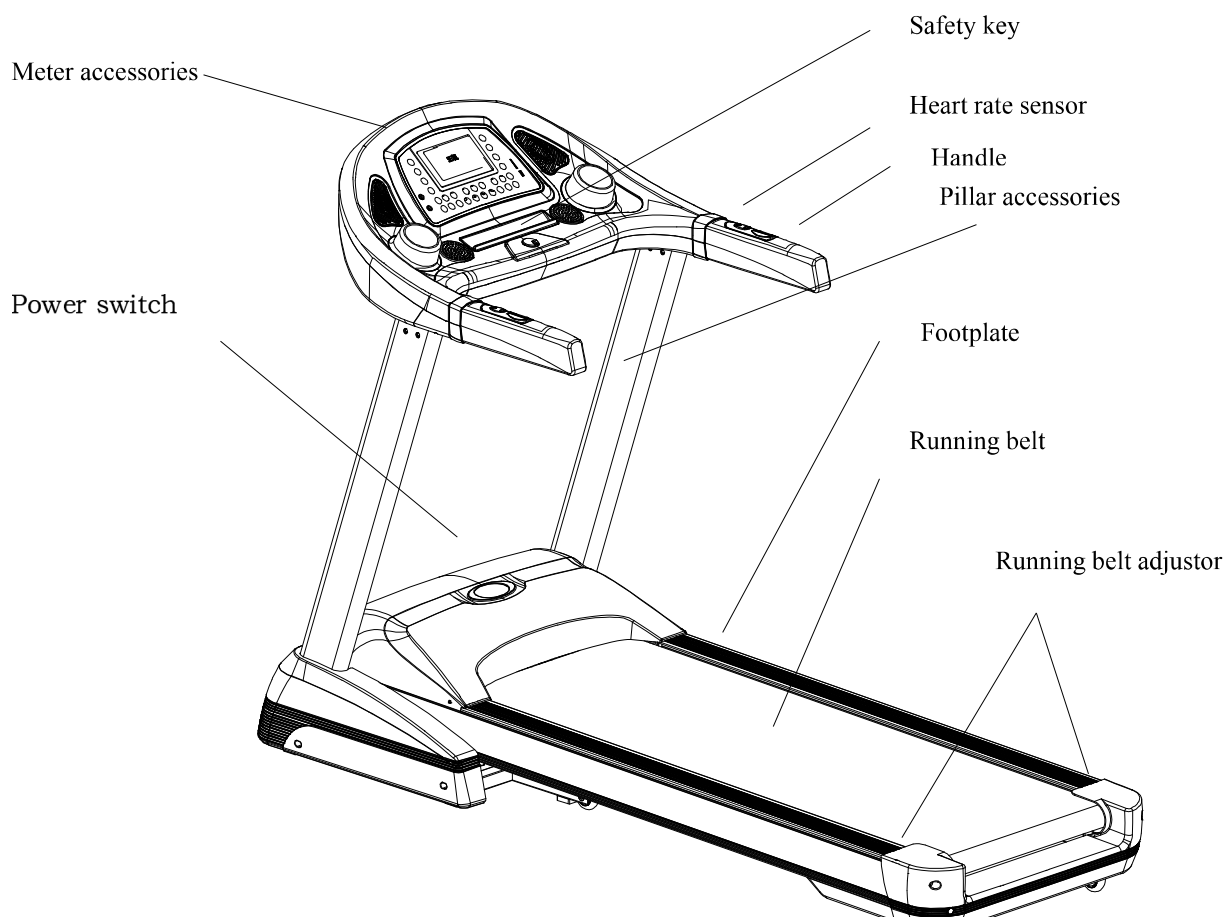

Diagram 1: GV-5055 Motorized Treadmill

2. Main Technical Features

Main use: Body and beauty building

This treadmill is for home use

Panel displays speed, time, distance, heart rate, calorie, MP3, bodyfat, etc.

Display Mode: LCD

Motor power: DC3.0HP

Input voltage: 220V±10%

Frequency: 50Hz

Temperature for working: 0~40°C

Speed range: 1~22km/h

Auto incline: 0-22

Time display range:0:00~99:59(minute : second);
Distance display range:0.1~99.99kms
Machine size (L*W*H): 1890x850x1290 (mm)
N/W: 81KGS; GW: 92KGS
MADE IN CHINA

3.1 Please consult your doctor at first before running, if you have one of the following diseases.

- a) Cardiopathy, hypertension, sugar diabetes, respiratory disease, smoking, and other chronic diseases, complication disease.
- b) If you are over 35 years old and heavier than common weight.
- c) Women in pregnant or in breasting period.

3.2 Please stop exercising immediately and consult your doctor if you're feel giddy, surfeit, thorax ache or other symptoms.

3.3 Please drink adequate water after taking exercises on our treadmill for more than 20 minutes.

4. Installation: See "Installation sketch"

5. Use and Operation

5.1 Panel Keys and Function

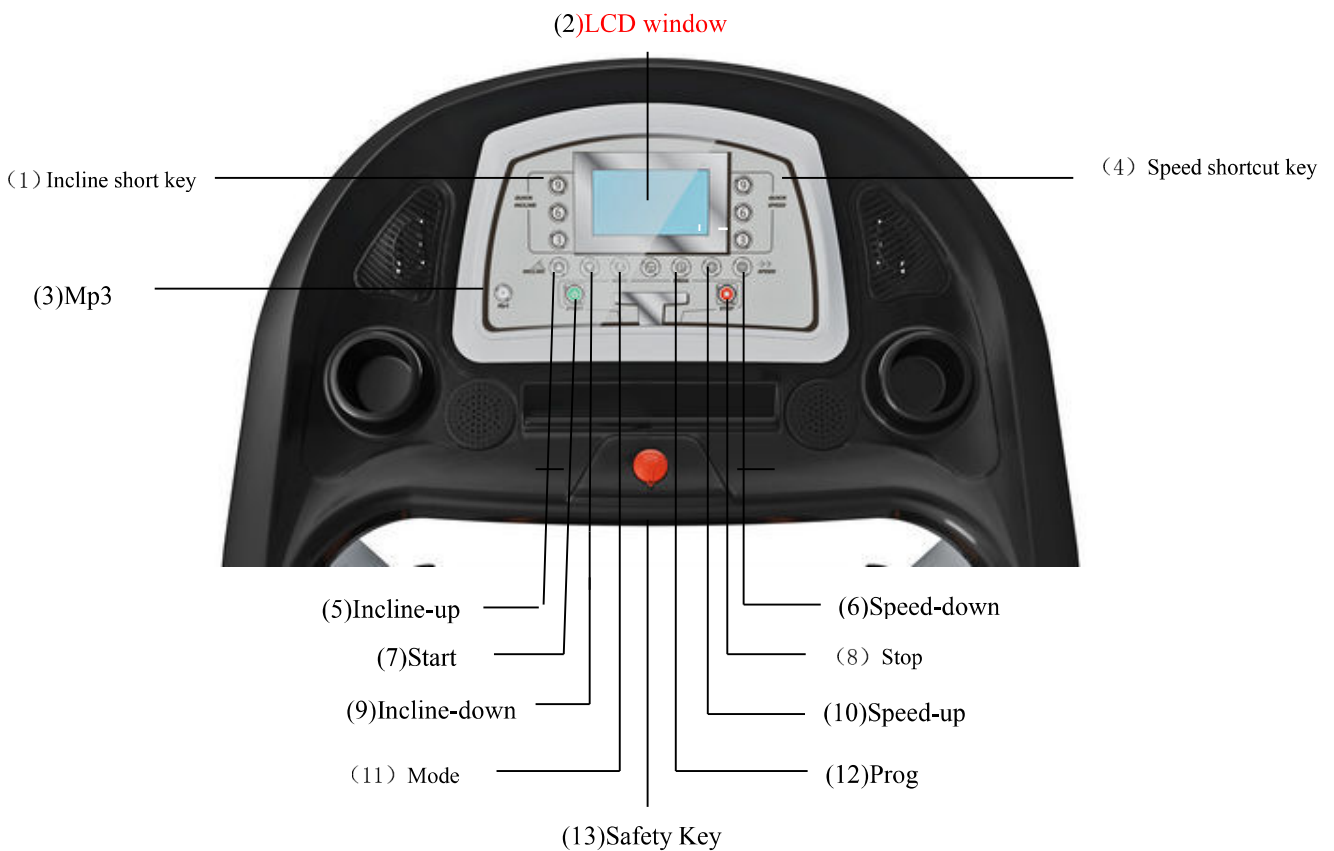

(1) “incline short cut key”

Press this key, the incline goes directly to the chosen height.

(2) LCD window

1. “incline” : It shows auto incline (range:0-22)

2. “distance”: It shows the distance.(range:0 km-99.99km)

3. “time”: It shows time. (range:00:00 -99:59)

4. “speed”: It shows speed. (range:1km/h-22km/h)

5. “cal/pulse”: It shows the pulse when it has, if without pulse, it shows calorie (range:0-999 calorie)

6. MP3: It will be displayed when MP3 function is in use.

(3) “music”

Press this key to open or shut the speaker amplify

(4) “speed short cut key”

Under running condition, press this key, speed can be set to the value directly.

(5) “incline up”

Press this key one by one or Press it continuously, you can choose the incline you need, except for the alarm condition.

(6) . “speed down”

Under running condition, press this key, speed can be speeded down to the one you need.

(7) “start”

Under ready condition, press this key, it runs at the speed of 1.0km/h.

(8) “stop”

Under running condition, press this key, if it runs at speed more than 3.5km/h, it will slow down then stop. During this stopping process, other keys are not available. If it runs at speed less than 3km/h, then it stops immediately.

(9) “incline down”

Press this key one by one or Press it continuously, you can choose the incline you need, except for the alarm condition.

(10) “speed up”

Under running condition, press this key, speed can be speeded up to the one you need.

(11) “mode”

Under ready condition, press this key to set time, distance and calorie accordingly. Press “speed-up” or “speed-down” keys to set the value of time, distance and calorie. Then press “start” key, the machine will run at 1.0km/h. And the set figures will be counted down, when it comes to “0”, machine stops.

(12) “Prog” (could be pressed continuously to your expected mode)

Press the “PROG” key once again to enter “48 direct selected programs” there are 48 programs, “P1-P24” the first 24 programs without incline, the last 24 programs including incline. So please choose carefully.

(13) “Safety key”

Under urgent condition, pull this key, machine stops immediately.

5.2 Unload operating

1. Insert power plug into the socket with earth wire, turn the switch to “1” position which is on the frame
2. Put the safe key in the right position, then circuit is on, press “on/off”, keep it run in unload condition. Test the condition of running belt (testing from low speed to high ones), after testing, press “on/off”.
3. If everything is ok, then start to run.

5.3 Meter operating instruction

5.3.1

1. Insert power plug into the socket with earth wire, turn the switch to “1” position which is on the frame. Place the safe key to the appointed position. After a few seconds, panel will show that the machine is ready.
2. Nip another end of safe key to your clothes, and stand on the footplate on both sides.
3. Press “on/off” key, running belt moves at the lowest speed (1.0km/h). Speed windows will display your running speed.
4. Start to run.
5. Press speed key or incline key to adjust speed and incline, speed window and incline window will display your speed and incline .
6. To end your exercise in a safe way, please first press “on/off” key to close the treadmill. Please leave the running belt until it stops slowly. Turn off the power.

5.3.2 Heart Rate Testing

Our treadmill can test your heart rate via the heart rate sensor. The data is only for reference.

5.4 Folding and Opening Treadmill

5.4.1 Folding

Firstly lift and fold the back part of the frame board by hand till you hear a light sound, which means the folding system has been locked. At this time running board can't be turned to the opposite direction

5.4.2 Opening

Put the folded treadmill in a capacious position when you want to run. Then pull the adjusting parts by hand to keep it is unlocked. Press the back part by your hands down to about 10%, release it, then it will open automatically.

6. Guides for malfunction

6.1 Analyzing and eliminating malfunction

Item.	Malfunction	Reasons	Solution
1	Treadmill can't be started	The safe key isn't in the right position	Put the safe key in the right position
		The electrical switch is placed to “0”	Turn the electrical switch to “1”

		creepage switch is not OPEN	Replace creepage switch
2	Meter can't display	The meter control line and control panel are unconnected	Pull the bolt out and open the motor cover and reconnect it Turn on the meter and reconnect
3	Heart rate can't be displayed	The pole of heart rate sensor is not wet enough	Wet the pole with water or liquor for hard contact lenses
		Disturbed by electromagnetism	Stay away from electromagnetism
4	Incline doesn't work	The motor wire is not well connected	Open the motor cover and reconnect it
5	Running belt runs faster or slower than what has been displayed	Unadjusted	Readjust it
6	Running belt slips	Running belt is not tight enough	Please read point 6.3 Adjustment steps for tightening running belt for reference
7	Running belt is deflected	The running belt is unadjusted.	Please read point 6.4 The steps for adjusting the deflected running belt for reference

6.2 If you still can't solve the problems after taking the solutions above, we hope that you can contact our dealer or company as soon as possible.

7 Error and self-inspection

7.1 Error : Treadmill gives the following error code if anything wrong , please contact the professional service people soon if it happens.

Error Code	Reason
E-01	Didn't detect signal from the speed indicator.
E-02	The Voltage is overload and exceed the marked (volt)
E-03	The motor is overload and exceed the marked (amps).
E-04	Incorrect connection between main motor and control panel
E-06	Poor connection between the display and controller.
E-07	Safety key of electronic meter has been placed off.
E-09	Incline self-inspection failure
E-0P	Speed self-inspection failure
E-0C	Poor connection of motor wire to <u>controller</u> , damaged IGBT or defective circuit of power relay.

7.2 Self-inspection

No need to self-inspect unless special situation. If necessary, please do it under the instruction of professional technical people or sales because of the high voltage.

a, open the red power switch, pull out the safe key

b, Press the "start" and "speed +" key at the same time and keep it, meanwhile, use another hand to put on the safe key, then release the button of "start" and "speed+" and press the "mode" key, then the LCD start to show all the data inside

c, after the LCD display finished, then press the "mode" key again.

d, the treadmill runs from the lowest speed to highest speed, meanwhile, the incline is also from lowest to highest. Then treadmill stopped.

. The whole self-inspection process takes about 2 minutes

Motorized Treadmill Installing Sketch Map

1)

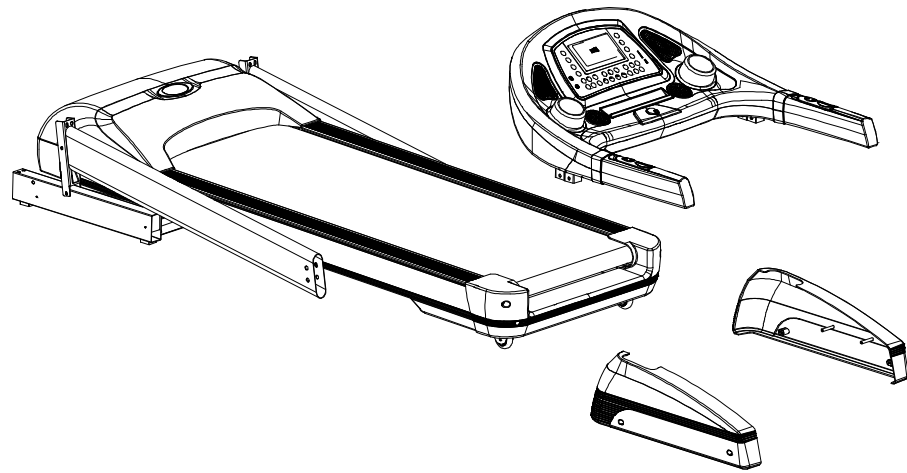

2)

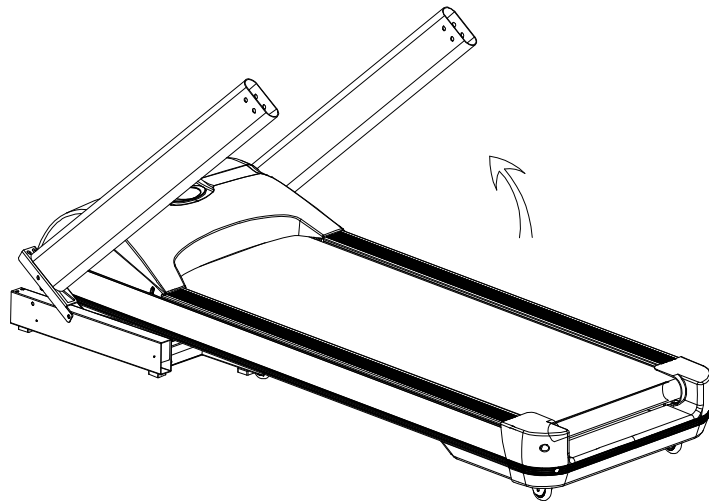

3)

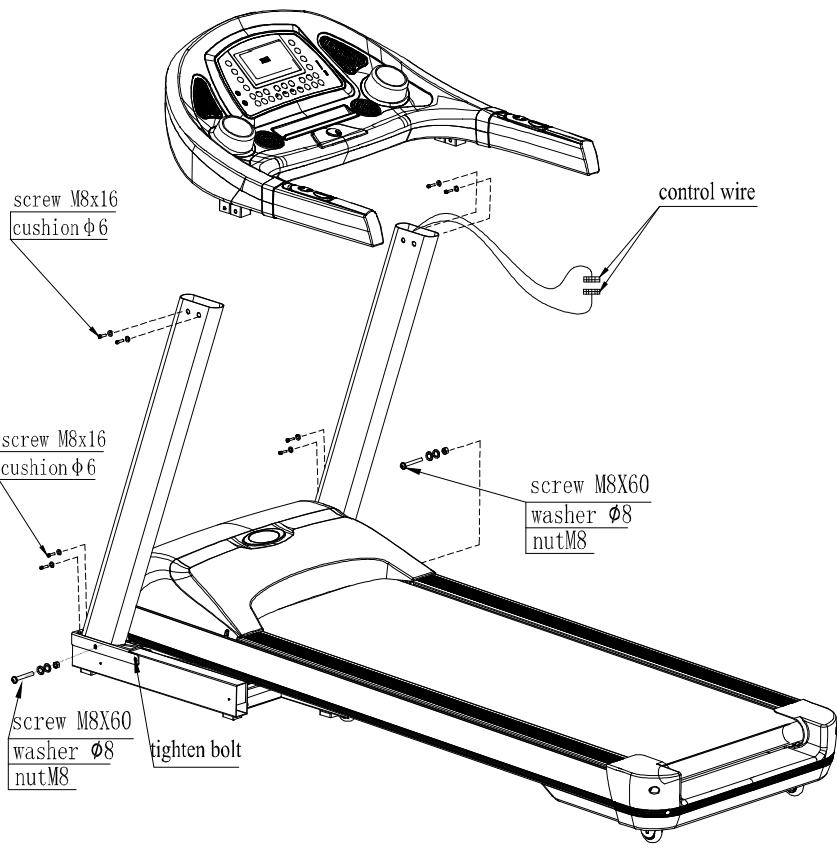

4)

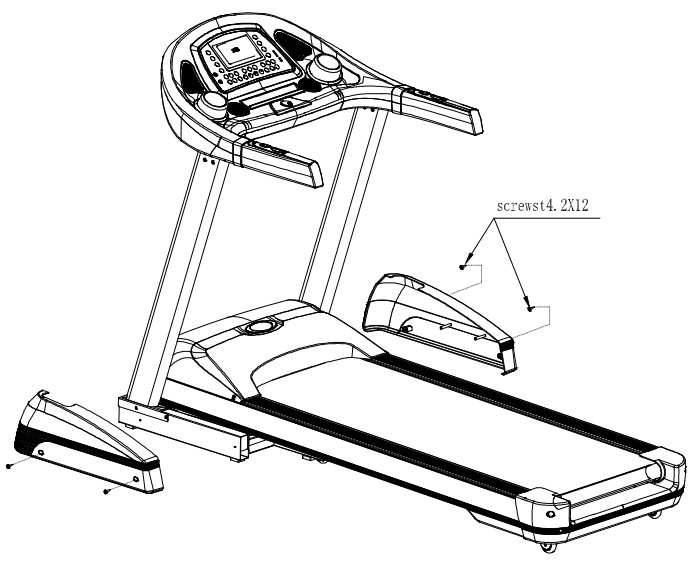

Program profile

Prog	SEG	1	2	3	4	5	6	7	8	9	10	11	12	13	14	15	16	17	18	19	20	21	22	23	24	25	26	27	28	29	30
P1	Speed/km/h	2	3	4	6	7	6	5	4	3	4	6	7	6	5	3	4	6	7	5	4	6	5	3	4	6	7	5	4	3	2

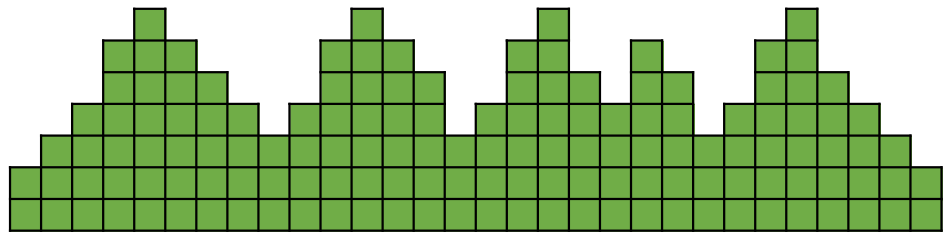

Prog	SEG	1	2	3	4	5	6	7	8	9	10	11	12	13	14	15	16	17	18	19	20	21	22	23	24	25	26	27	28	29	30
P2	Speed/km/h	3	5	7	9	1	9	7	5	7	9	1	9	7	5	7	9	1	9	7	5	7	5	7	9	1	9	7	5	3	2

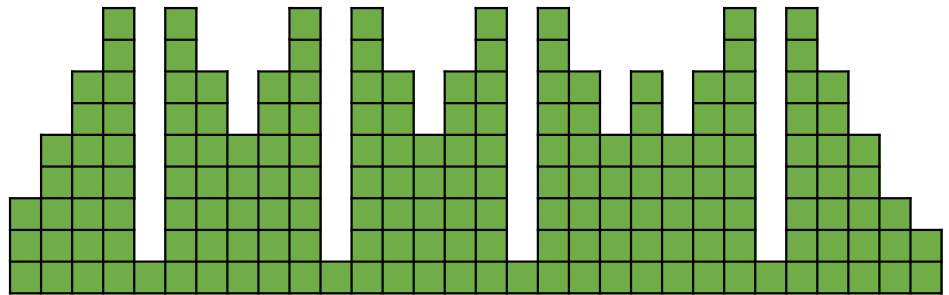

Prog	SEG	1	2	3	4	5	6	7	8	9	10	11	12	13	14	15	16	17	18	19	20	21	22	23	24	25	26	27	28	29	30
P3	Speed/km/h	2	4	6	8	8	8	6	5	6	8	8	8	6	5	6	8	8	8	6	5	6	5	6	8	8	8	6	5	4	3

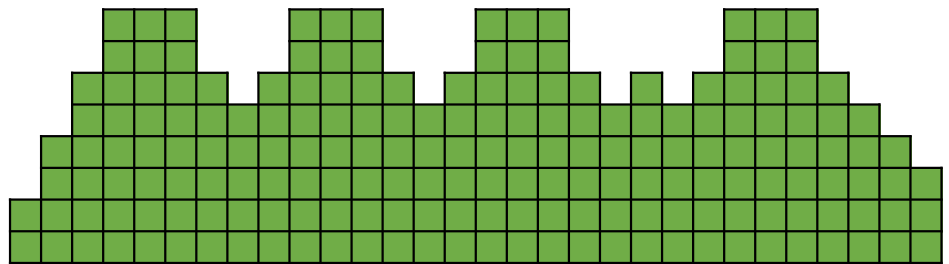

Prog	SEG	1	2	3	4	5	6	7	8	9	10	11	12	13	14	15	16	17	18	19	20	21	22	23	24	25	26	27	28	29	30
P4	Speed/km/h	2	3	4	6	7	6	5	4	4	6	7	6	5	4	4	6	7	6	5	4	5	4	4	6	7	6	5	4	3	2

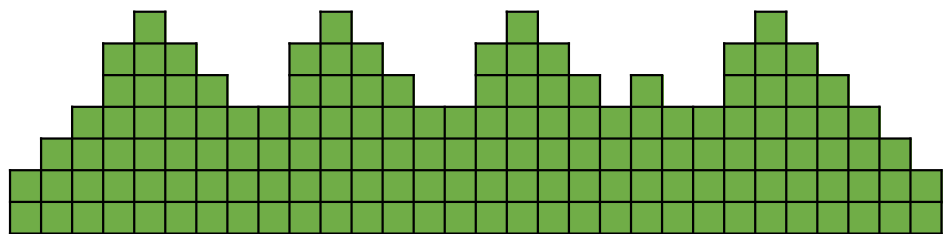

Prog	SEG	1	2	3	4	5	6	7	8	9	10	11	12	13	14	15	16	17	18	19	20	21	22	23	24	25	26	27	28	29	30
P5	Speed/km/h	1	3	5	7	10	7	7	5	5	7	10	7	7	5	5	7	10	7	7	5	7	5	5	7	10	7	7	5	3	1

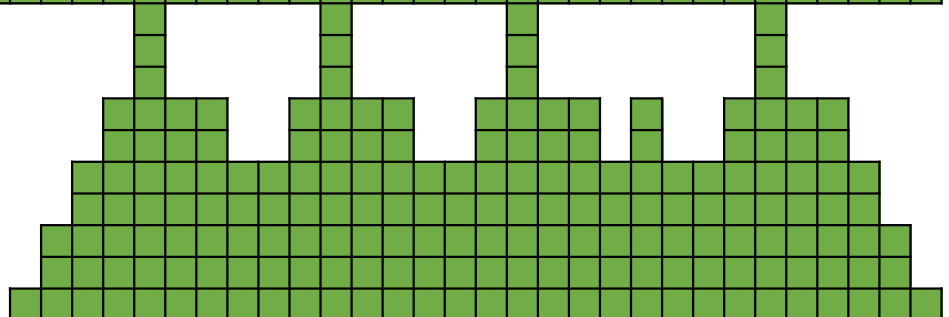

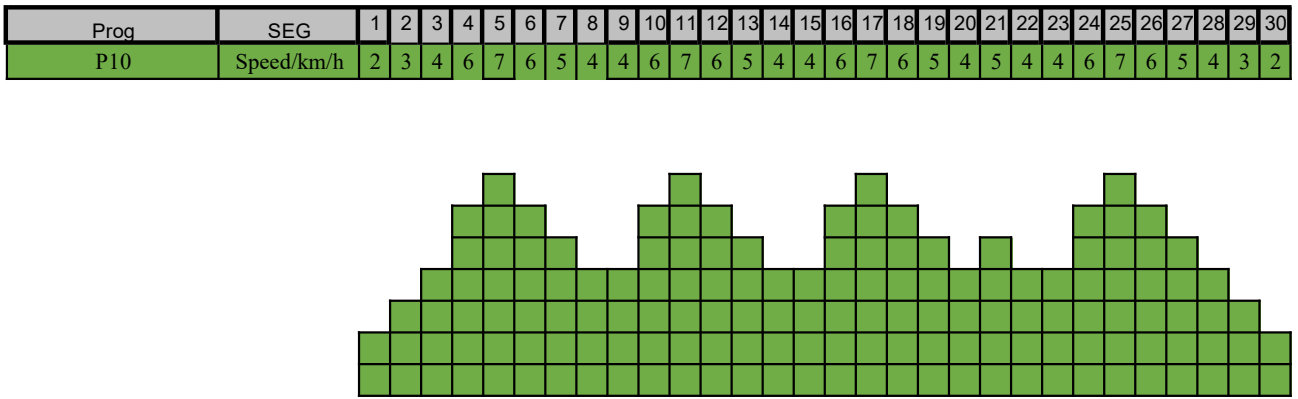
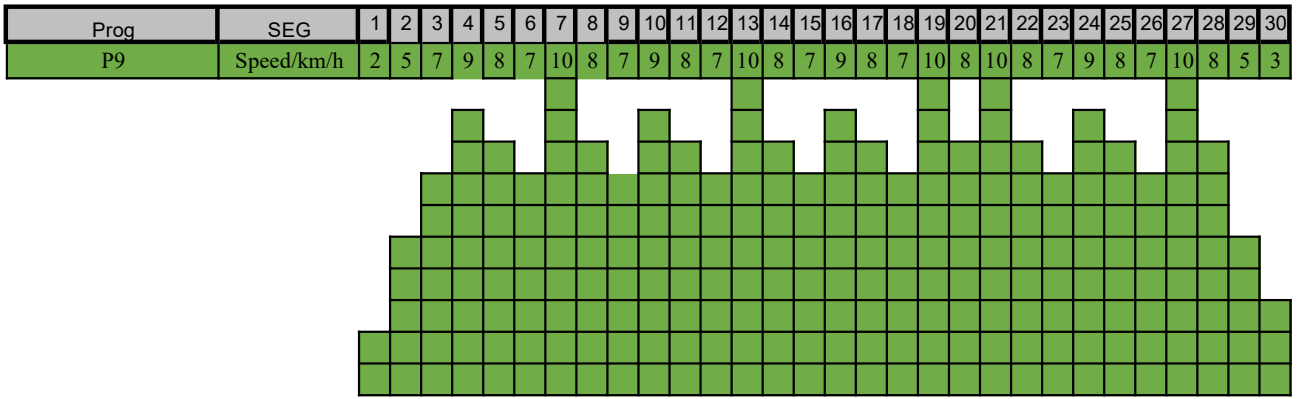
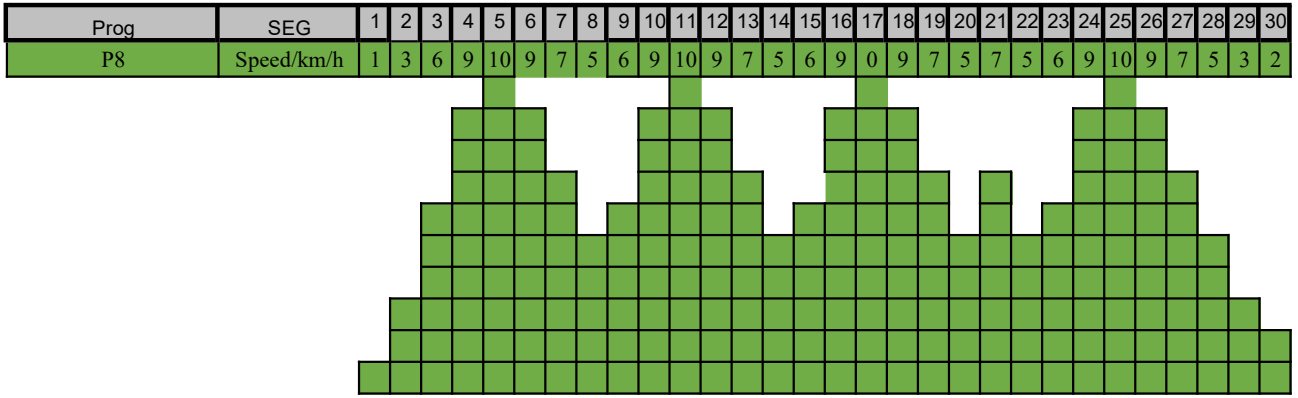
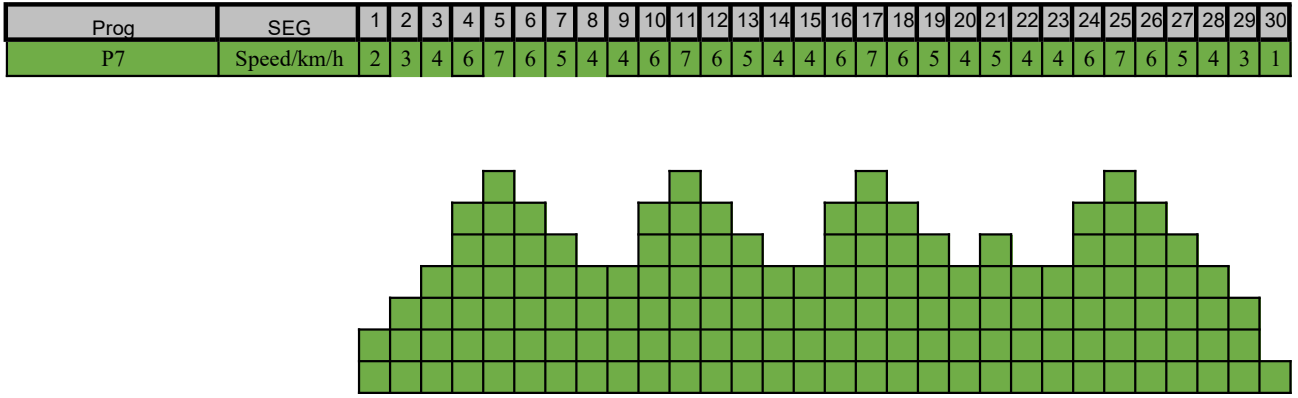
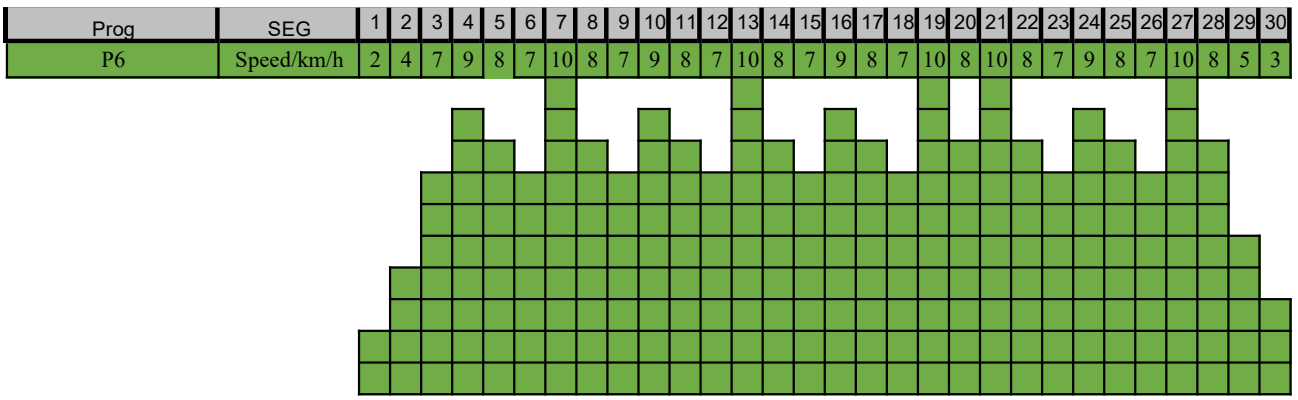

Prog	SEG	1	2	3	4	5	6	7	8	9	10	11	12	13	14	15	16	17	18	19	20	21	22	23	24	25	26	27	28	29	30
P11	Speed/km/h	1	2	4	6	9	9	10	7	4	6	9	9	10	7	4	6	9	9	10	7	10	7	4	6	9	9	10	7	5	3

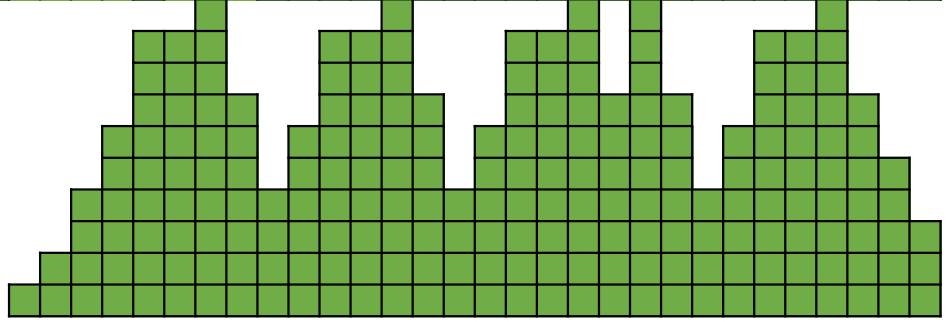

Prog	SEG	1	2	3	4	5	6	7	8	9	10	11	12	13	14	15	16	17	18	19	20	21	22	23	24	25	26	27	28	29	30
P12	Speed/km/h	2	5	7	9	8	7	10	8	7	9	8	7	10	8	7	9	8	7	10	8	10	8	7	9	8	7	10	8	5	3

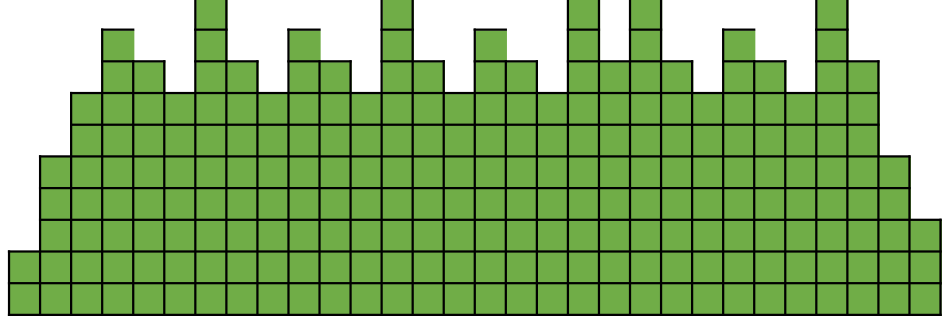

Prog	SEG	1	2	3	4	5	6	7	8	9	10	11	12	13	14	15	16	17	18	19	20	21	22	23	24	25	26	27	28	29	30
P13	Speed/km/h	2	3	4	6	8	6	5	4	4	6	8	6	5	4	4	6	8	6	5	4	5	4	4	6	8	6	5	4	3	2

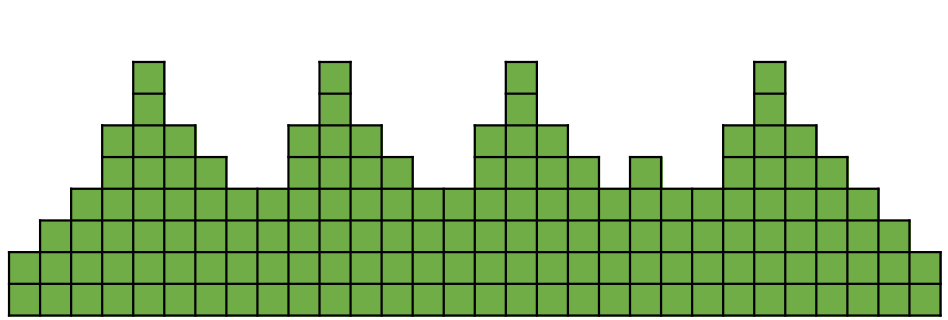

Prog	SEG	1	2	3	4	5	6	7	8	9	10	11	12	13	14	15	16	17	18	19	20	21	22	23	24	25	26	27	28	29	30
P14	Speed/km/h	3	5	7	8	1	9	6	5	7	8	1	9	6	5	7	8	1	9	6	5	6	5	7	8	1	9	6	5	3	2

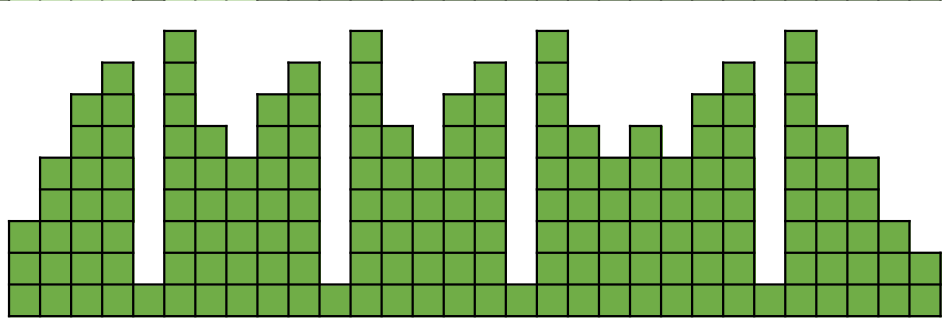

Prog	SEG	1	2	3	4	5	6	7	8	9	10	11	12	13	14	15	16	17	18	19	20	21	22	23	24	25	26	27	28	29	30
P15	Speed/km/h	2	4	5	7	8	9	6	5	5	7	8	9	6	5	5	7	8	9	6	5	6	5	5	7	8	9	6	5	4	3

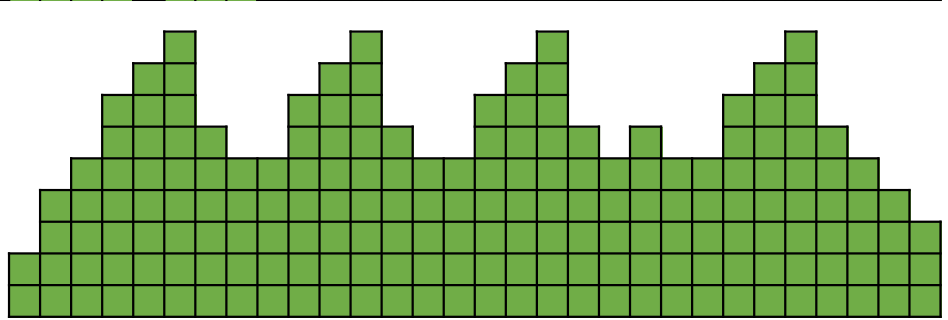

Prog	SEG	1	2	3	4	5	6	7	8	9	10	11	12	13	14	15	16	17	18	19	20	21	22	23	24	25	26	27	28	29	30
P16	Speed/km/h	1	3	4	5	7	6	5	4	4	5	7	6	5	4	4	5	7	6	5	4	5	4	4	5	7	6	5	4	3	1

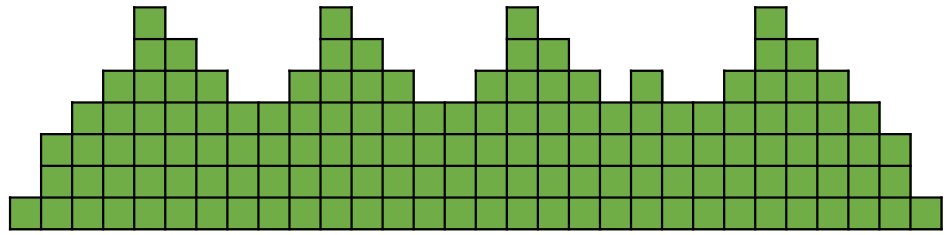

Prog	SEG	1	2	3	4	5	6	7	8	9	10	11	12	13	14	15	16	17	18	19	20	21	22	23	24	25	26	27	28	29	30
P17	Speed/km/h	1	3	5	7	8	7	6	5	5	7	8	7	6	5	5	7	8	7	6	5	6	5	5	7	8	7	6	5	3	2

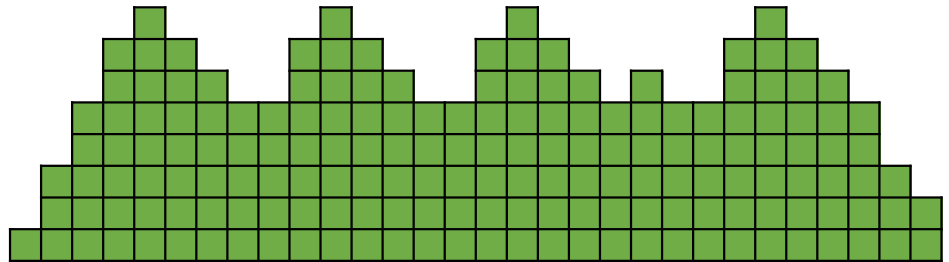

Prog	SEG	1	2	3	4	5	6	7	8	9	10	11	12	13	14	15	16	17	18	19	20	21	22	23	24	25	26	27	28	29	30
P18	Speed/km/h	2	4	6	8	9	7	10	8	6	8	9	7	10	8	6	8	9	7	10	8	10	8	6	8	9	7	10	8	5	3

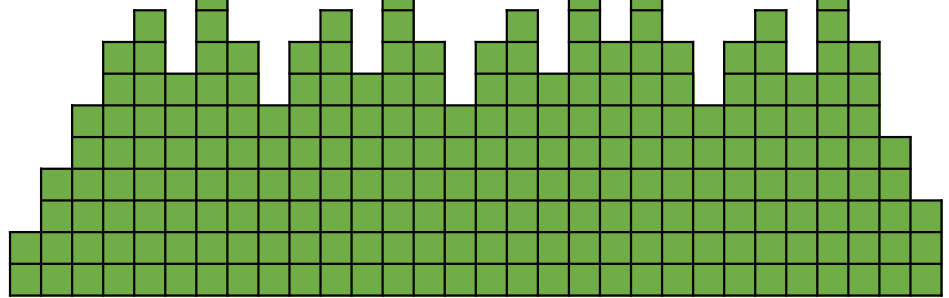

Prog	SEG	1	2	3	4	5	6	7	8	9	10	11	12	13	14	15	16	17	18	19	20	21	22	23	24	25	26	27	28	29	30
P19	Speed/km/h	1	3	4	6	7	6	5	4	4	6	7	6	5	4	4	6	7	6	5	4	5	4	4	6	7	6	5	4	3	2

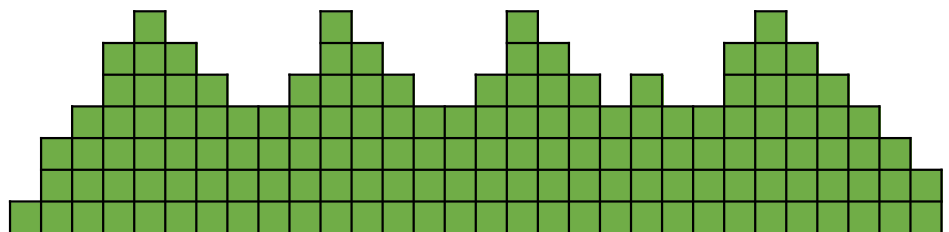

Prog	SEG	1	2	3	4	5	6	7	8	9	10	11	12	13	14	15	16	17	18	19	20	21	22	23	24	25	26	27	28	29	30
P20	Speed/km/h	1	3	5	8	10	9	7	5	5	8	10	9	7	5	5	8	10	9	7	5	7	5	5	8	10	9	7	5	3	2

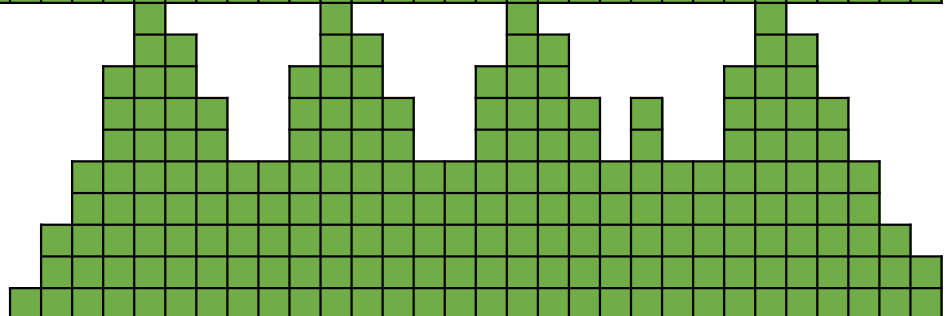

Prog	SEG	1	2	3	4	5	6	7	8	9	10	11	12	13	14	15	16	17	18	19	20	21	22	23	24	25	26	27	28	29	30
P21	Speed/km/h	2	5	7	9	8	7	6	8	7	9	8	7	6	8	7	9	8	7	6	8	6	8	7	9	8	7	6	8	5	2

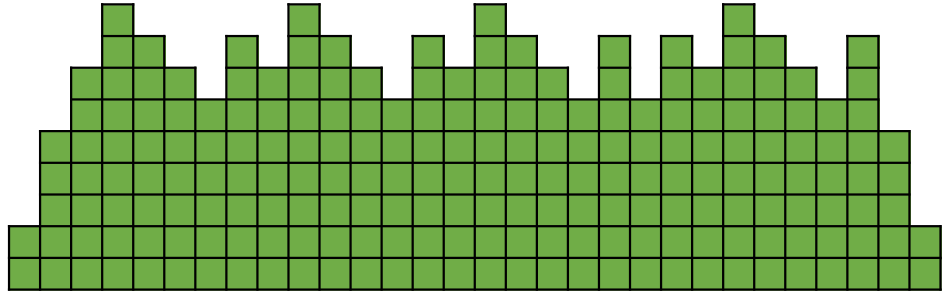

Prog	SEG	1	2	3	4	5	6	7	8	9	10	11	12	13	14	15	16	17	18	19	20	21	22	23	24	25	26	27	28	29	30
P22	Speed/km/h	2	3	4	5	6	6	5	4	4	5	6	6	5	4	4	5	6	6	5	4	5	4	4	5	6	6	5	4	3	2

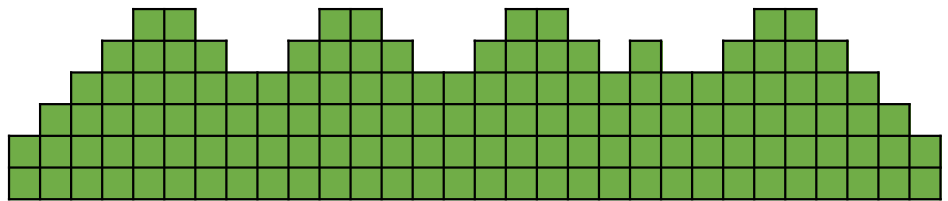

Prog	SEG	1	2	3	4	5	6	7	8	9	10	11	12	13	14	15	16	17	18	19	20	21	22	23	24	25	26	27	28	29	30
P23	Speed/km/h	1	2	4	5	9	9	8	7	4	5	9	9	8	7	4	5	9	9	8	7	8	7	4	5	9	9	8	7	5	3

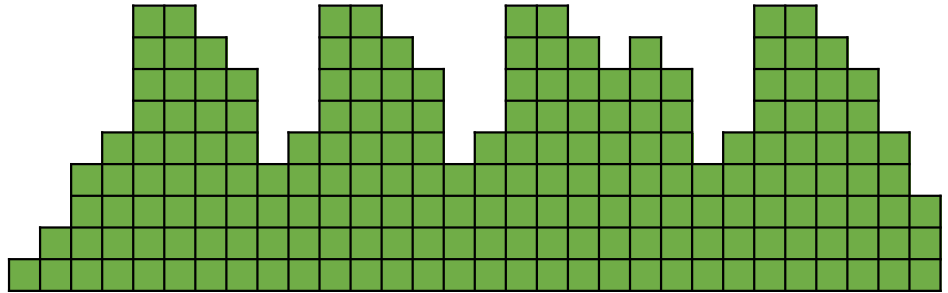

Prog	SEG	1	2	3	4	5	6	7	8	9	10	11	12	13	14	15	16	17	18	19	20	21	22	23	24	25	26	27	28	29	30
P24	Speed/km/h	2	5	7	8	9	7	10	8	7	8	9	7	10	8	7	8	9	7	10	8	10	8	7	8	9	7	10	8	6	3

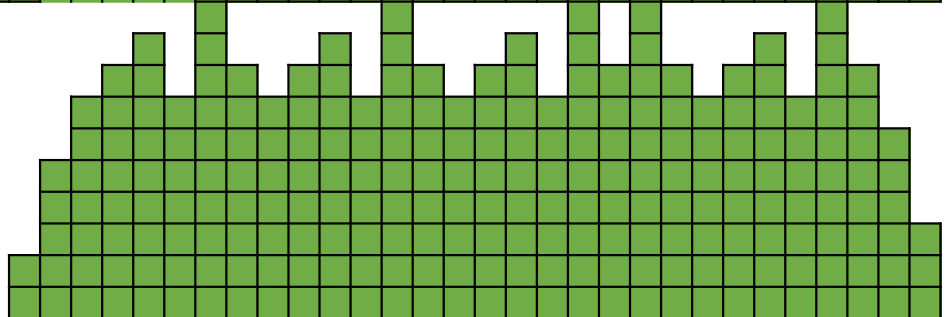

Program profile

Prog	SEG	1	2	3	4	5	6	7	8	9	10	11	12	13	14	15	16	17	18	19	20	21	22	23	24	25	26	27	28	29	30
P25	Speed/km/h	1	3	4	5	7	6	5	4	4	5	7	6	5	4	4	5	7	6	5	4	5	4	4	5	7	6	5	4	3	2
	Incline/Step	2	3	2	4	3	2	3	1	2	4	3	2	3	1	2	4	3	2	3	1	3	1	2	4	3	2	3	1	0	2

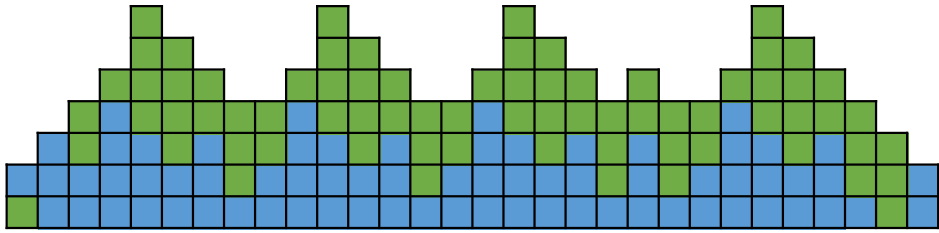

Prog	SEG	1	2	3	4	5	6	7	8	9	10	11	12	13	14	15	16	17	18	19	20	21	22	23	24	25	26	27	28	29	30
Program 26	Speed/km/h	3	6	7	9	7	9	7	5	7	9	7	9	7	5	7	9	7	9	7	5	7	5	7	9	7	9	7	5	3	2
	Incline/Step	1	0	2	5	3	4	6	4	2	5	3	4	6	4	2	5	3	4	6	4	6	4	2	5	3	4	6	4	3	1

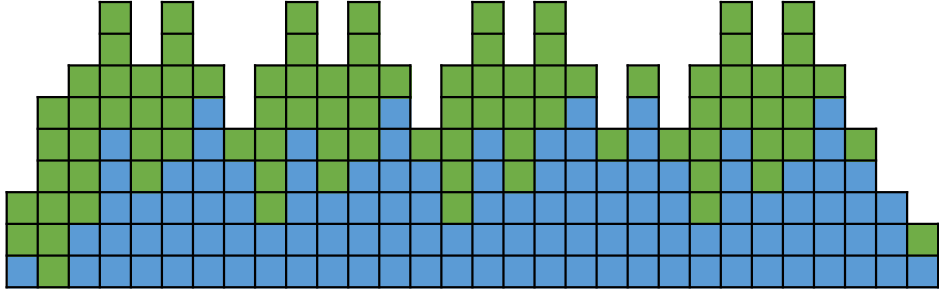

Prog	SEG	1	2	3	4	5	6	7	8	9	10	11	12	13	14	15	16	17	18	19	20	21	22	23	24	25	26	27	28	29	30
P27	Speed/km/h	2	4	6	8	9	8	6	5	6	8	9	8	6	5	6	8	9	8	6	5	6	5	6	8	9	8	6	5	4	3
	Incline/Step	0	1	2	3	4	5	6	4	2	3	4	5	6	4	2	3	4	5	6	4	6	4	2	3	4	5	6	4	3	2

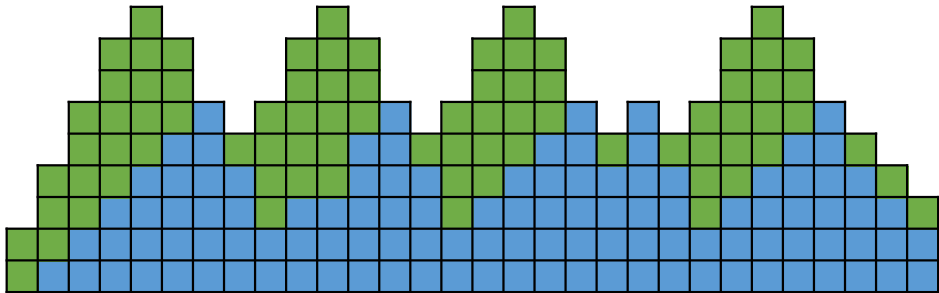

Prog	SEG	1	2	3	4	5	6	7	8	9	10	11	12	13	14	15	16	17	18	19	20	21	22	23	24	25	26	27	28	29	30
P28	Speed/km/h	2	3	4	6	7	6	5	4	4	6	7	6	5	4	4	6	7	6	5	4	5	4	4	6	7	6	5	4	3	2
	Incline/Step	3	3	2	2	0	4	0	3	2	2	0	4	0	3	2	2	0	4	0	3	0	3	2	2	0	4	0	3	3	1

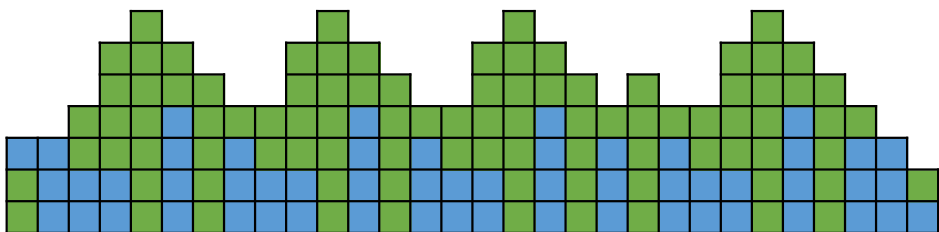

Prog	SEG	1	2	3	4	5	6	7	8	9	10	11	12	13	14	15	16	17	18	19	20	21	22	23	24	25	26	27	28	29	30
P29	Speed/km/h	1	3	5	7	10	7	7	5	5	7	10	7	7	5	5	7	10	7	7	5	7	5	5	7	10	7	7	5	3	1
	Incline/Step	0	2	4	1	3	5	2	1	4	1	3	5	2	1	4	1	3	5	2	1	2	1	4	1	3	5	2	1	3	1

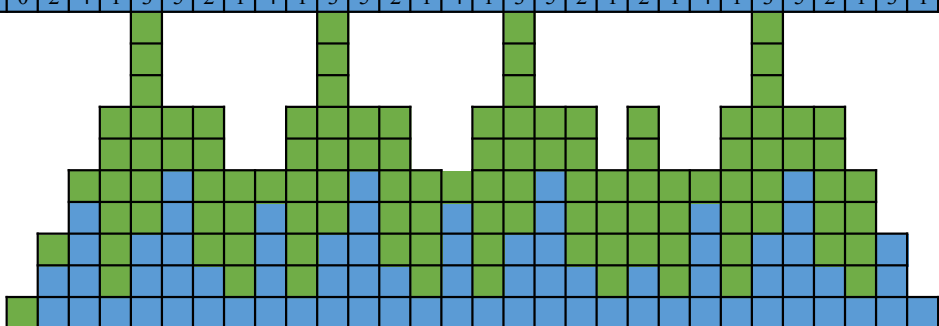

Prog	SEG	1	2	3	4	5	6	7	8	9	10	11	12	13	14	15	16	17	18	19	20	21	22	23	24	25	26	27	28	29	30
P30	Speed/km/h	2	4	7	9	8	7	10	8	7	8	7	10	8	7	9	8	7	10	8	10	8	7	9	8	7	10	8	5	3	
	Incline/Step	2	0	3	2	3	5	2	4	3	2	3	5	2	4	3	2	3	5	2	4	2	4	3	2	3	5	2	4	3	2

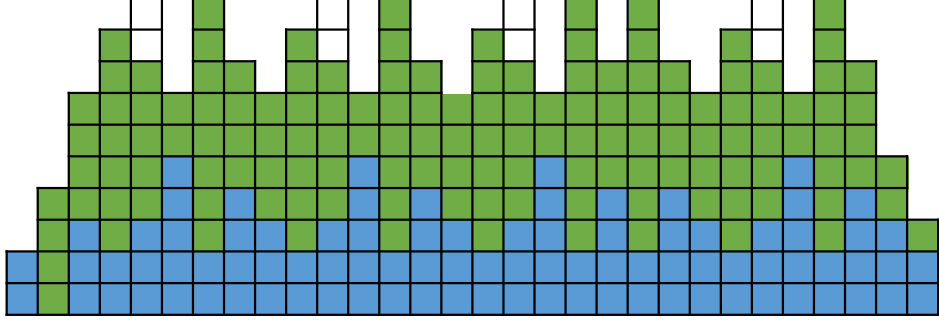

Prog	SEG	1	2	3	4	5	6	7	8	9	10	11	12	13	14	15	16	17	18	19	20	21	22	23	24	25	26	27	28	29	30
P31	Speed/km/h	2	3	4	5	7	6	5	4	4	5	7	6	5	4	4	5	7	6	5	4	5	4	4	5	7	6	5	4	3	1
	Incline/Step	3	1	2	2	3	4	5	3	2	2	3	4	5	3	2	2	3	4	5	3	5	3	2	2	3	4	5	3	4	3

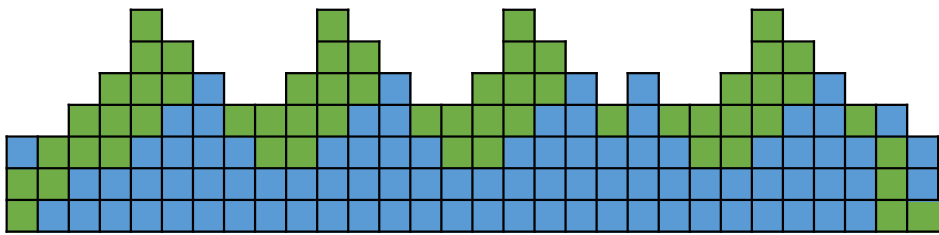

Prog	SEG	1	2	3	4	5	6	7	8	9	10	11	12	13	14	15	16	17	18	19	20	21	22	23	24	25	26	27	28	29	30
P32	Speed/km/h	1	3	6	9	8	9	7	5	6	9	8	9	7	5	6	9	8	9	7	5	7	5	6	9	8	9	7	5	3	2
	Incline/Step	0	2	1	3	2	4	5	2	1	3	2	4	5	2	1	3	2	4	5	2	5	2	1	3	2	4	5	2	3	1

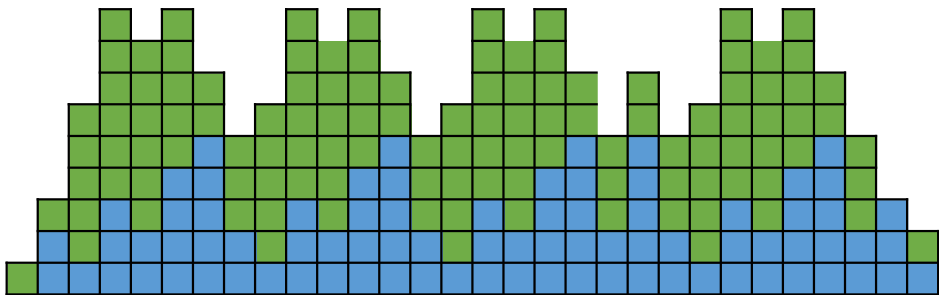

Prog	SEG	1	2	3	4	5	6	7	8	9	10	11	12	13	14	15	16	17	18	19	20	21	22	23	24	25	26	27	28	29	30
P33	Speed/km/h	2	5	7	9	8	7	9	8	7	9	8	7	9	8	7	9	8	7	9	8	9	8	7	9	8	7	9	8	5	3
	Incline/Step	0	1	2	3	4	6	4	2	2	3	4	6	4	2	2	3	4	6	4	2	4	2	2	3	4	6	4	2	5	3

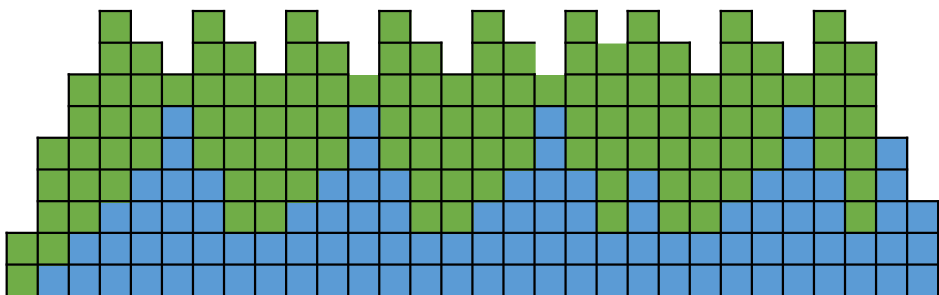

Prog	SEG	1	2	3	4	5	6	7	8	9	10	11	12	13	14	15	16	17	18	19	20	21	22	23	24	25	26	27	28	29	30
P34	Speed/km/h	2	3	4	6	7	6	5	4	4	6	7	6	5	4	4	6	7	6	5	4	5	4	4	6	7	6	5	4	3	1
	Incline/Step	2	3	4	3	4	5	5	3	4	3	4	5	5	3	4	3	4	5	5	3	5	3	4	3	4	5	5	3	3	2

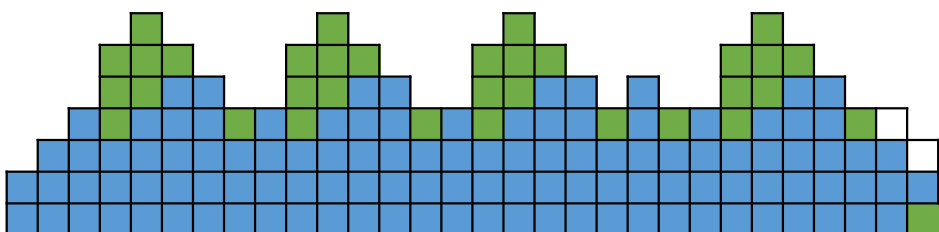

Prog	SEG	1	2	3	4	5	6	7	8	9	10	11	12	13	14	15	16	17	18	19	20	21	22	23	24	25	26	27	28	29	30
P35	Speed/km/h	1	2	3	6	9	8	10	7	3	6	9	8	10	7	3	6	9	8	10	7	10	7	3	6	9	8	10	7	5	3
	Incline/Step	0	2	0	1	3	4	2	1	0	1	3	4	2	1	0	1	3	4	2	1	2	1	0	1	3	4	2	1	3	1

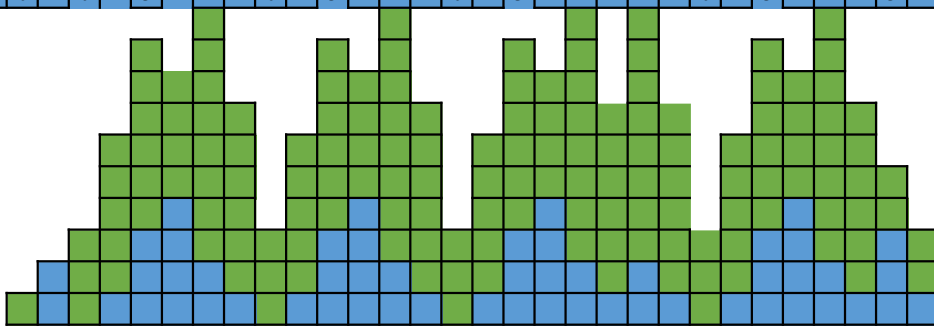

Prog	SEG	1	2	3	4	5	6	7	8	9	10	11	12	13	14	15	16	17	18	19	20	21	22	23	24	25	26	27	28	29	30
P36	Speed/km/h	2	4	7	9	8	7	9	8	7	9	8	7	9	8	7	9	8	7	9	8	9	8	7	9	8	7	9	8	5	2
	Incline/Step	0	3	6	4	3	1	4	5	6	4	3	1	4	5	6	4	3	1	4	5	4	5	6	4	3	1	4	5	2	1

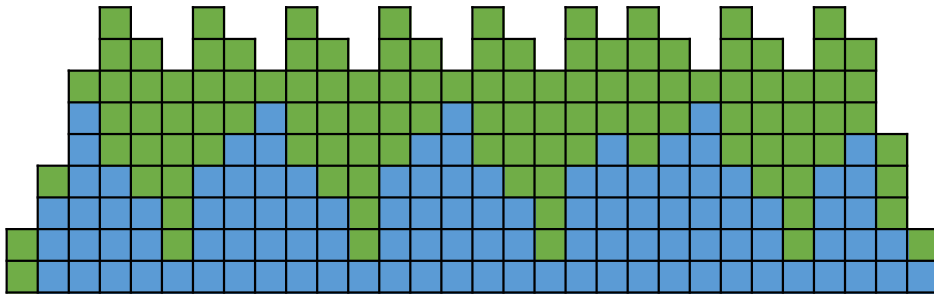

Prog	SEG	1	2	3	4	5	6	7	8	9	10	11	12	13	14	15	16	17	18	19	20	21	22	23	24	25	26	27	28	29	30
P37	Speed/km/h	2	3	4	5	7	8	6	4	4	5	7	8	6	4	4	5	7	8	6	4	6	4	4	5	7	8	6	4	3	2
	Incline/Step	2	3	2	4	3	2	3	1	2	4	3	2	3	1	2	4	3	2	3	1	3	1	2	4	3	2	3	1	0	2

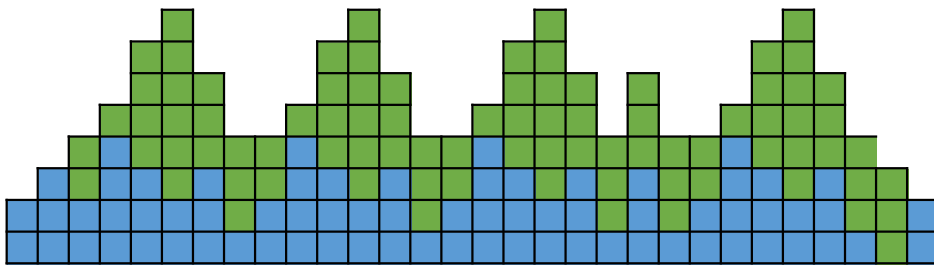

Prog	SEG	1	2	3	4	5	6	7	8	9	10	11	12	13	14	15	16	17	18	19	20	21	22	23	24	25	26	27	28	29	30
P38	Speed/km/h	3	5	7	8	2	8	7	5	7	8	2	8	7	5	7	8	2	8	7	5	7	5	7	8	2	8	7	5	3	2
	Incline/Step	1	0	2	5	3	4	6	4	2	5	3	4	6	4	2	5	3	4	6	4	6	4	2	5	3	4	6	4	3	1

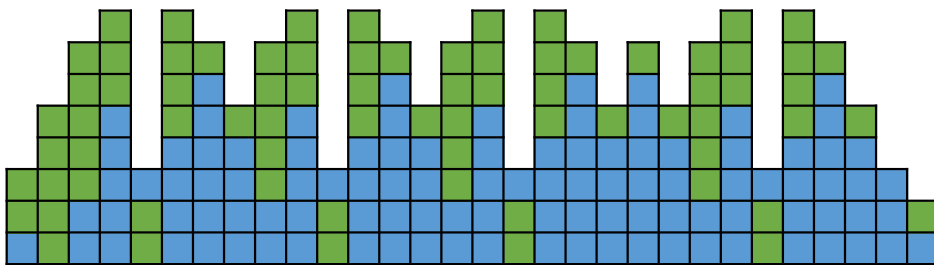

Prog	SEG	1	2	3	4	5	6	7	8	9	10	11	12	13	14	15	16	17	18	19	20	21	22	23	24	25	26	27	28	29	30
P39	Speed/km/h	2	4	6	8	7	8	6	4	6	8	7	8	6	4	6	8	7	8	6	4	6	4	6	8	7	8	6	4	4	3
	Incline/Step	0	1	2	3	4	5	6	4	2	3	4	5	6	4	2	3	4	5	6	4	6	4	2	3	4	5	6	4	3	2

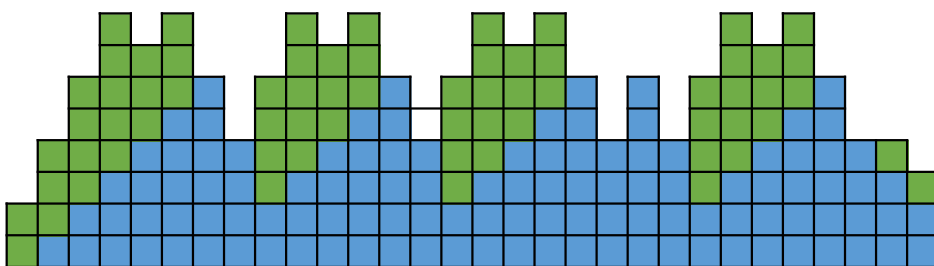

Prog	SEG	1	2	3	4	5	6	7	8	9	10	11	12	13	14	15	16	17	18	19	20	21	22	23	24	25	26	27	28	29	30
P40	Speed/km/h	1	3	4	6	7	8	6	4	4	6	7	8	6	4	4	6	7	8	6	4	6	4	4	6	7	8	6	4	2	2
	Incline/Step	3	3	2	2	0	4	0	3	2	2	0	4	0	3	2	2	0	4	0	3	0	3	2	2	0	4	0	3	3	1

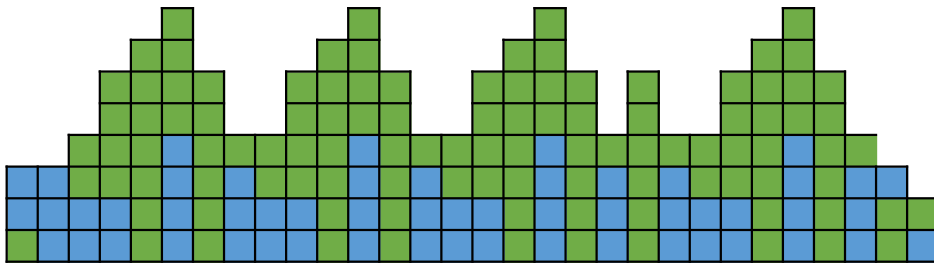

Prog	SEG	1	2	3	4	5	6	7	8	9	10	11	12	13	14	15	16	17	18	19	20	21	22	23	24	25	26	27	28	29	30
P41	Speed/km/h	1	3	5	7	9	7	5	3	5	7	9	7	5	3	5	7	9	7	5	3	5	3	5	7	9	7	5	3	2	1
	Incline/Step	0	2	4	1	3	5	2	1	4	1	3	5	2	1	4	1	3	5	2	1	2	1	4	1	3	5	2	1	3	1

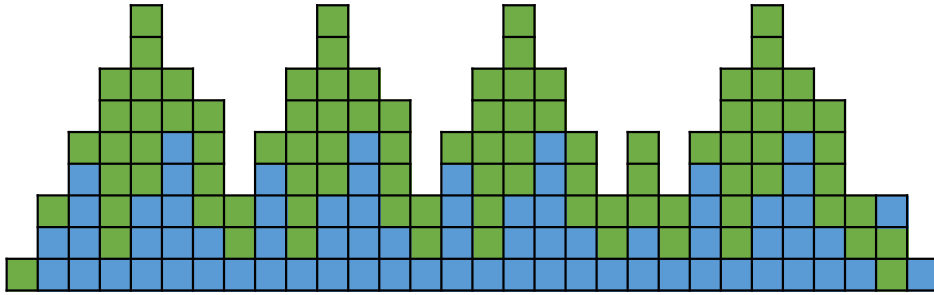

Prog	SEG	1	2	3	4	5	6	7	8	9	10	11	12	13	14	15	16	17	18	19	20	21	22	23	24	25	26	27	28	29	30
P42	Speed/km/h	2	4	7	7	8	7	9	8	7	7	8	7	9	8	7	7	8	7	9	8	9	8	7	7	8	7	9	8	6	3
	Incline/Step	2	0	3	2	3	5	2	4	3	2	3	5	2	4	3	2	3	5	2	4	2	4	3	2	3	5	2	4	3	2

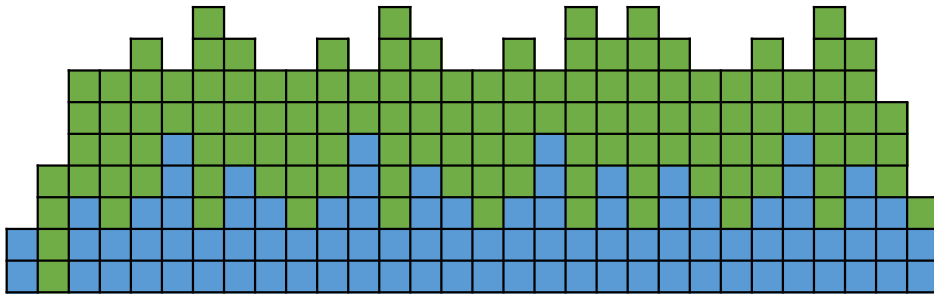

Prog	SEG	1	2	3	4	5	6	7	8	9	10	11	12	13	14	15	16	17	18	19	20	21	22	23	24	25	26	27	28	29	30
P43	Speed/km/h	2	3	4	5	6	7	8	6	4	5	6	7	8	6	4	5	6	7	8	6	8	6	4	5	6	7	8	6	3	2
	Incline/Step	3	1	2	2	3	4	5	3	2	2	3	4	5	3	2	2	3	4	5	3	5	3	2	2	3	4	5	3	4	3

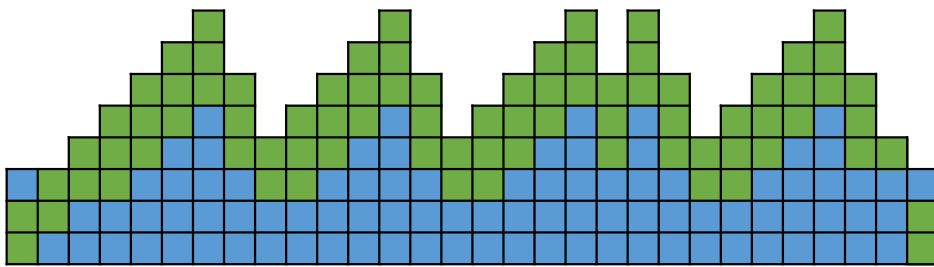

Prog	SEG	1	2	3	4	5	6	7	8	9	10	11	12	13	14	15	16	17	18	19	20	21	22	23	24	25	26	27	28	29	30
P44	Speed/km/h	1	3	6	8	10	9	7	6	6	8	10	9	7	6	6	8	10	9	7	6	7	6	6	8	10	9	7	6	3	2
	Incline/Step	0	2	1	3	2	4	5	2	1	3	2	4	5	2	1	3	2	4	5	2	5	2	1	3	2	4	5	2	3	1

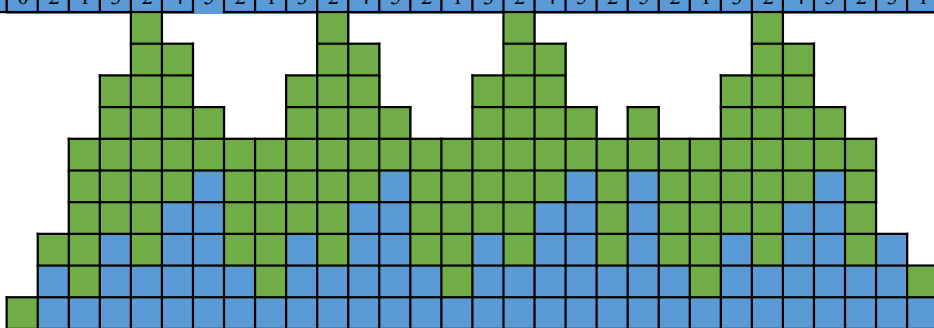

Prog	SEG	1	2	3	4	5	6	7	8	9	10	11	12	13	14	15	16	17	18	19	20	21	22	23	24	25	26	27	28	29	30
P45	Speed/km/h	2	5	7	9	8	7	9	8	7	9	8	7	9	8	7	9	8	7	9	8	9	8	7	9	8	7	9	8	5	3
	Incline/Step	0	1	2	3	4	6	4	2	2	3	4	6	4	2	2	3	4	6	4	2	4	2	2	3	4	6	4	2	5	3

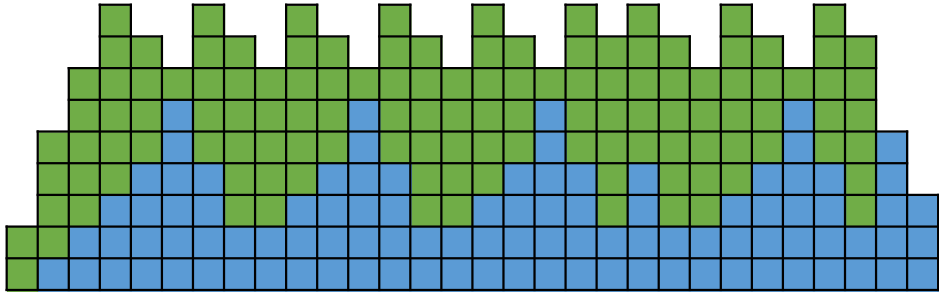

Prog	SEG	1	2	3	4	5	6	7	8	9	10	11	12	13	14	15	16	17	18	19	20	21	22	23	24	25	26	27	28	29	30
P46	Speed/km/h	2	4	4	6	7	6	5	4	4	6	7	6	5	4	4	6	7	6	5	4	5	4	4	6	7	6	5	4	2	2
	Incline/Step	2	3	4	3	4	5	5	3	4	3	4	5	5	3	4	3	4	5	5	3	5	3	4	3	4	5	5	3	3	2

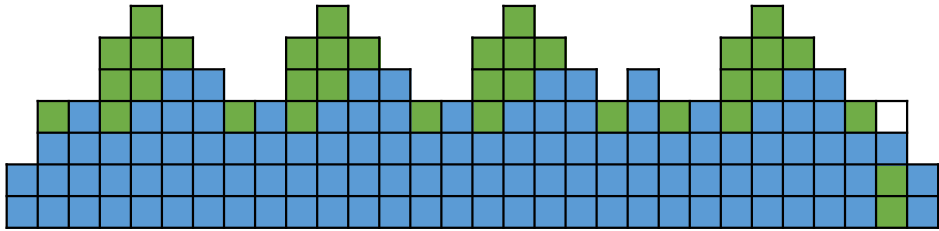

Prog	SEG	1	2	3	4	5	6	7	8	9	10	11	12	13	14	15	16	17	18	19	20	21	22	23	24	25	26	27	28	29	30
P47	Speed/km/h	1	2	4	6	8	9	10	7	4	6	8	9	10	7	4	6	8	9	10	7	10	7	4	6	8	9	10	7	5	3
	Incline/Step	0	2	0	1	3	4	2	1	0	1	3	4	2	1	0	1	3	4	2	1	2	1	0	1	3	4	2	1	3	1

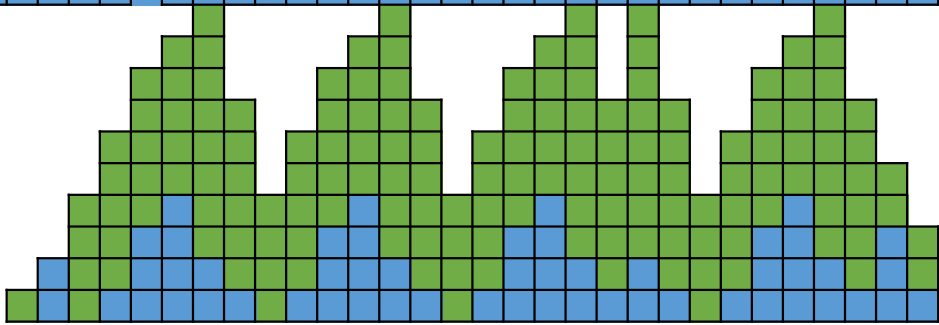

Prog	SEG	1	2	3	4	5	6	7	8	9	10	11	12	13	14	15	16	17	18	19	20	21	22	23	24	25	26	27	28	29	30
P48	Speed/km/h	2	5	7	8	8	7	10	8	7	8	8	7	10	8	7	8	8	7	10	8	10	8	7	8	8	7	10	8	5	3
	Incline/Step	0	2	0	1	3	4	2	1	0	1	3	4	2	1	0	1	3	4	2	1	2	1	0	1	3	4	2	1	3	1

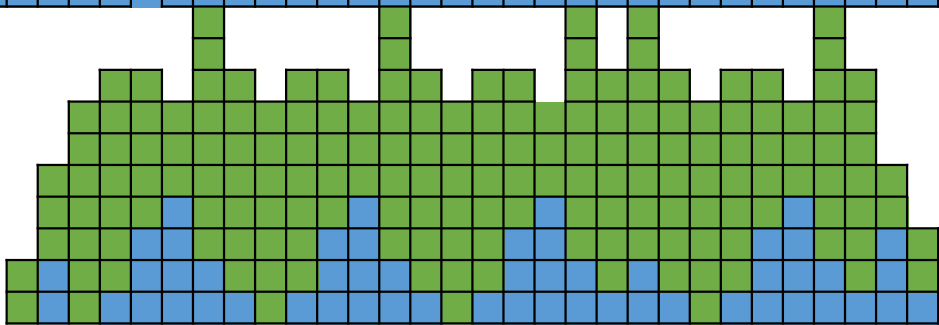

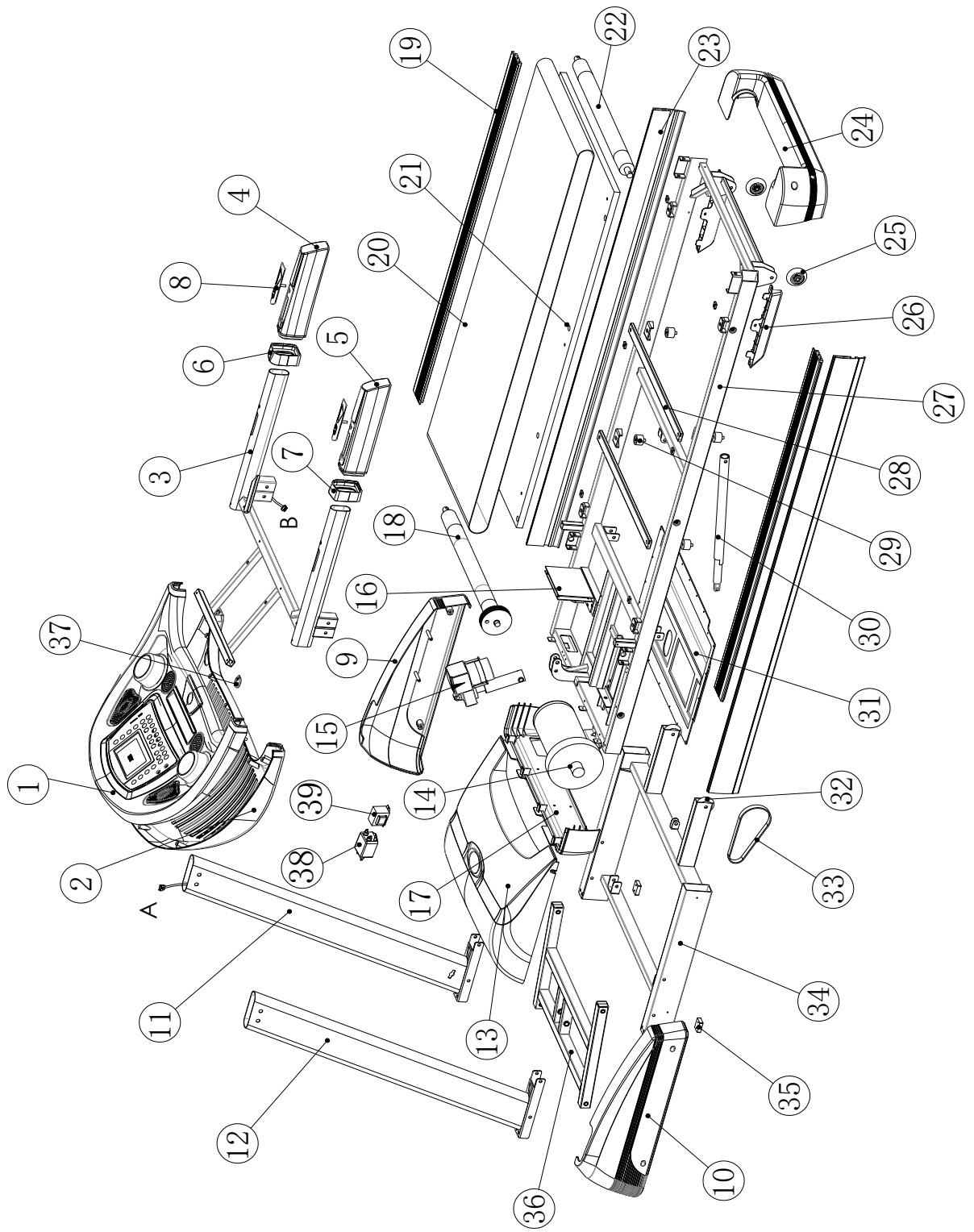

No.	part		No.	part		No.	part	
1	仪表底盖	The bottom display plastic	15	升降电机	Incline motor	29	弹性垫块	Cushion block
2	仪表上盖	The upper display plastic	16	下控	Motor control board	30	气弹簧	Gas spring
3	仪表架	Display holder	17	电机罩-前盖	Front motor cover	31	底遮板	Bottom cover
4	扶手套-右	Handrail foam-right	18	前滚筒	Front roller	32	底座移动轮	wheel
5	扶手套-左	Handrail foam-left	19	上装饰条	Upper strip	33	多楔带	Motor belt
6	扶手套接环-右	Handrail socket ring-right	20	跑带	Running belt	34	底座架	Base frame
7	扶手套接环-左	Handrail socket ring-left	21	跑板	Running deck	35	橡胶块	Rubber block
8	心率传感器	Heart rate sensor	22	后滚筒	Real roller	36	升降架	Incline frame
9	装饰盖-右	Protection cover-right	23	侧装饰条	Side strip	37	安全开关	Safety key
10	装饰盖-左	Protection cover-left	24	后堵头	End cap	38	滤波器	filter
11	右立管	Holder-right	25	跑台移动轮	wheel	39	电抗	reactor
12	左立管	Holder-left	26	下遮罩-左右	Bottom cover	A	Wiring(connect B wiring)	
13	电机罩上盖	Motor cover	27	跑台机架	frame	B	Wiring(connect B wiring)	
14	主电机	motor	28	跑板支撑管	The holder for running frame			

EU Declaration of Conformity

Object of the declaration:

Product TITAN LIFE TREADMILL T65

Model GV5055

Item number 270-200011

Producer Item number GV5055

Manufacturer NINGBO GUYUAN FITNESS CO.,LTD

Address No.177 XiaoGao West Road,ShouNan Street,Yinzhou
District.NingBO

This declaration of conformity is issued under the sole responsibility of the manufacturer.



This object of the declaration described above is in conformity with the relevant Union harmonization legislation:

Conformity is shown by compliance with the applicable requirements of the following documents:

